

LME 304768 UU IKO

Linear bushing

TYPE: Shaft guidance systems, Linear bushing, Standard, Close type, Type LME..(N) UU, sealed on both sides

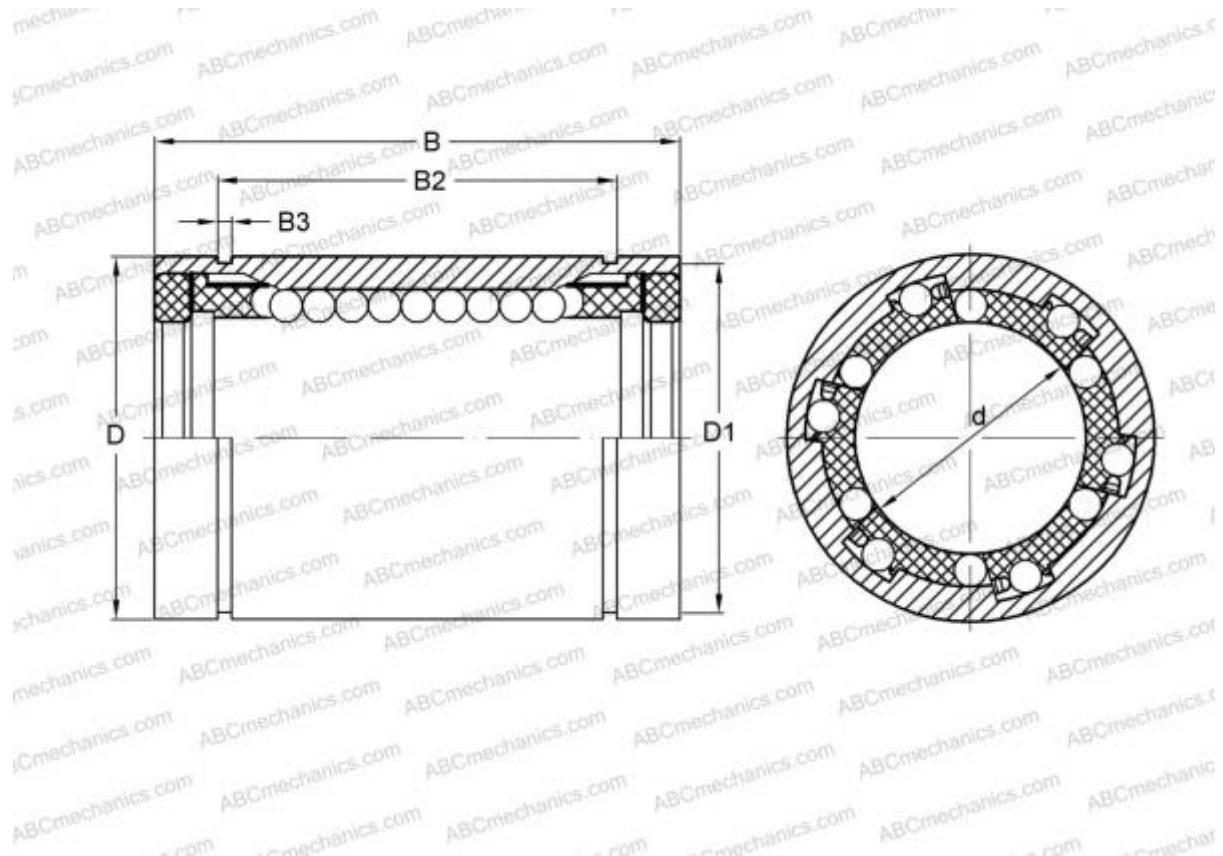

Technical specification

DIMENSIONS, MM

d	30,000
D	47,000
B	68,000

WEIGHT, KG 0,360

MANUFACTURER [IKO](#)

INTERCHANGE

ABC	LME 304768 UU
STAR	0602-030-10
THOMSON	0602-030-10

CALCULATION DATA

Basic dynamic load rating min	1,350 kN
Basic dynamic load rating max	1,430 kN
Basic static load rating min	2,500 kN

CALCULATION DATA

Basic static load rating max	3,200 kN
------------------------------	----------