

0612-020-10 THOMSON

Linear bushing

TYPE: Shaft guidance systems, Linear bushing, Standard, Adjustable type, Type LME..(N) UU AJ, sealed on both sides

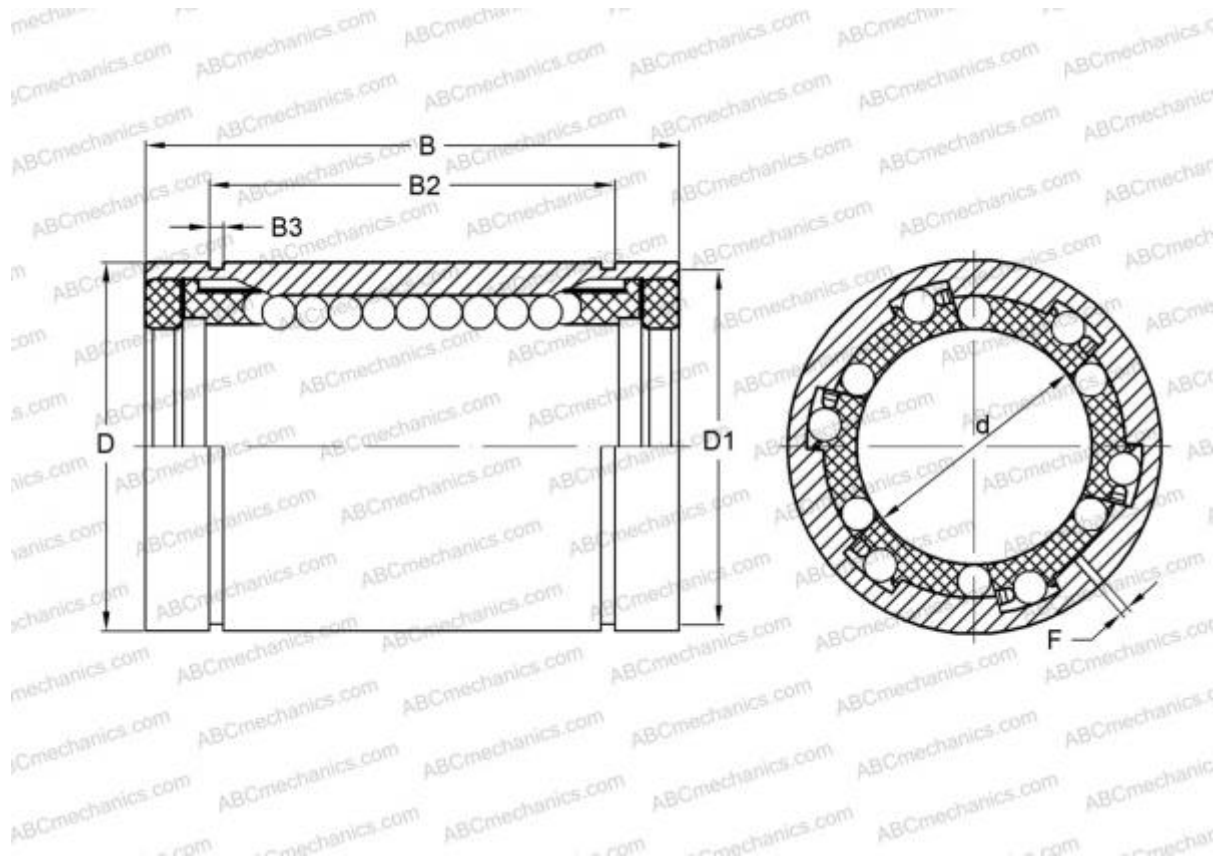

Technical specification

DIMENSIONS, MM

d	20,000
D	32,000
B	45,000
f	2,000

WEIGHT, KG 0,100

MANUFACTURER [THOMSON](#)

INTERCHANGE

ABC	LME 203245 UU AJ
IKO	LME 203245 UU AJ
STAR	0612-020-10