

LME 254058 UU AJ ABC

Linear bushing

TYPE: Shaft guidance systems, Linear bushing, Standard, Adjustable type, Type LME..(N) UU AJ, sealed on both sides

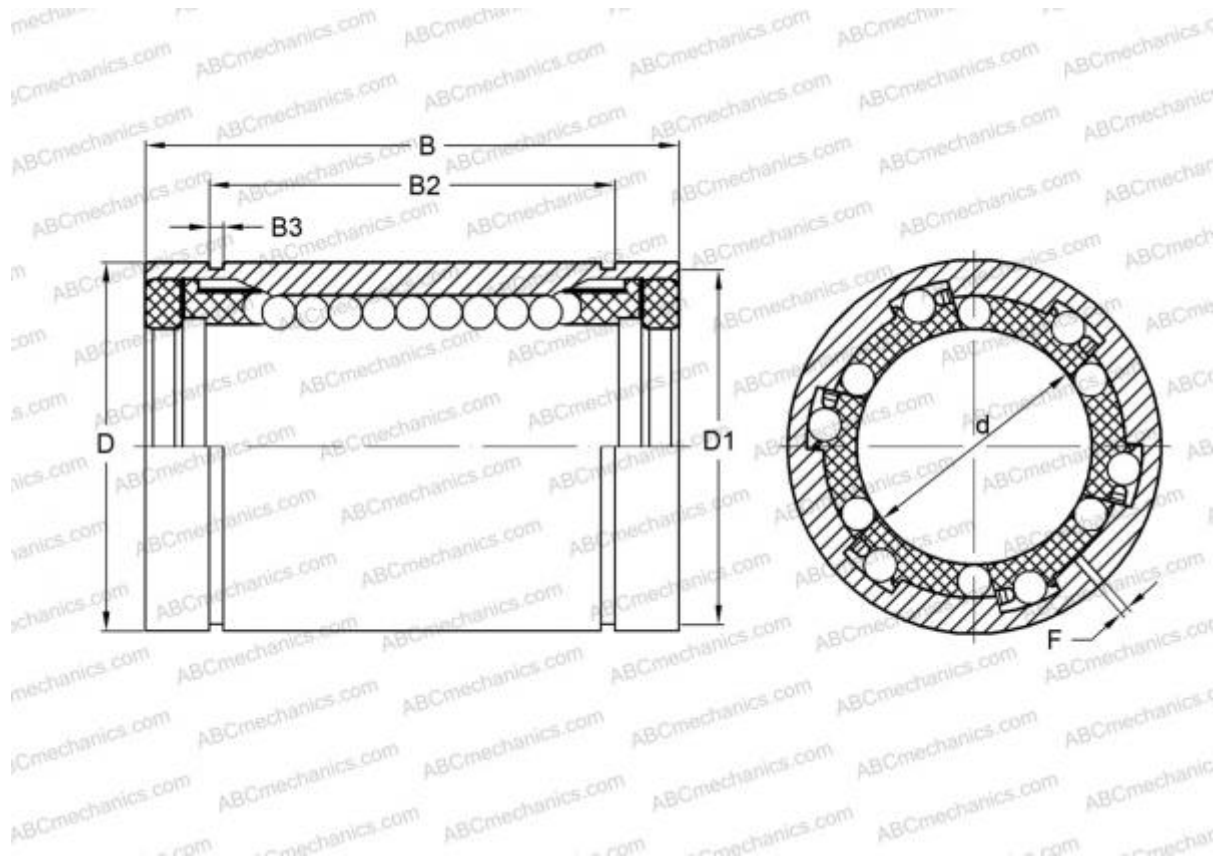

Technical specification

DIMENSIONS, MM

d	25,000
D	40,000
B	58,000
f	2,000

WEIGHT, KG 0,235

MANUFACTURER [ABC](#)

INTERCHANGE

IKO	LME 254058 UU AJ
STAR	0612-025-10
THOMSON	0612-025-10