

LME 254058 UU AJ IKO

Linear bushing

TYPE: Shaft guidance systems, Linear bushing, Standard, Adjustable type, Type LME..(N) UU AJ, sealed on both sides

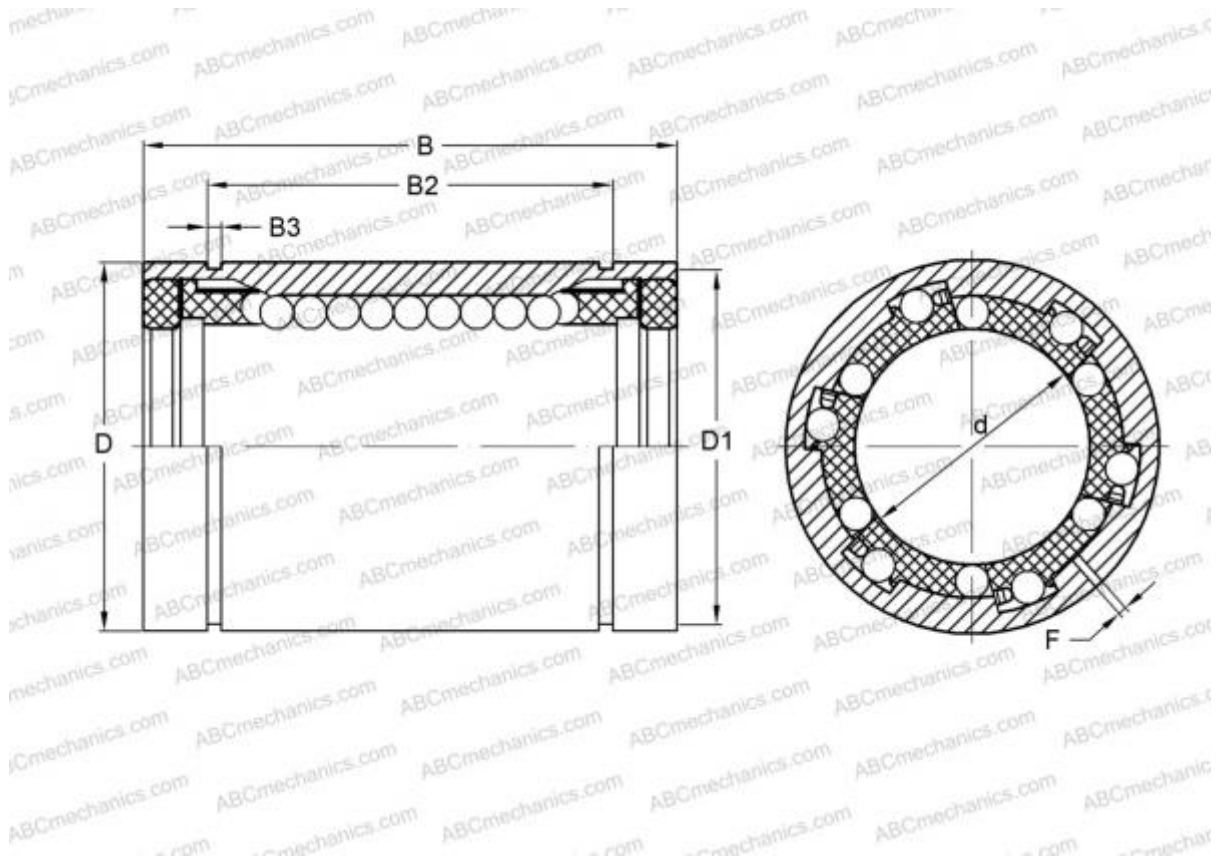

Technical specification

DIMENSIONS, MM

d	25,000
D	40,000
B	58,000
f	2,000

WEIGHT, KG 0,235

MANUFACTURER [IKO](#)

INTERCHANGE

ABC	LME 254058 UU AJ
STAR	0612-025-10
THOMSON	0612-025-10

CALCULATION DATA

Basic dynamic load rating min	0,920 kN
Basic dynamic load rating max	0,974 kN

CALCULATION DATA

Basic static load rating min	1,780 kN
Basic static load rating max	2,280 kN