

## 0612-025-10 STAR

Linear bushing

TYPE: Shaft guidance systems, Linear bushing, Standard, Adjustable type, Type LME..(N) UU AJ, sealed on both sides

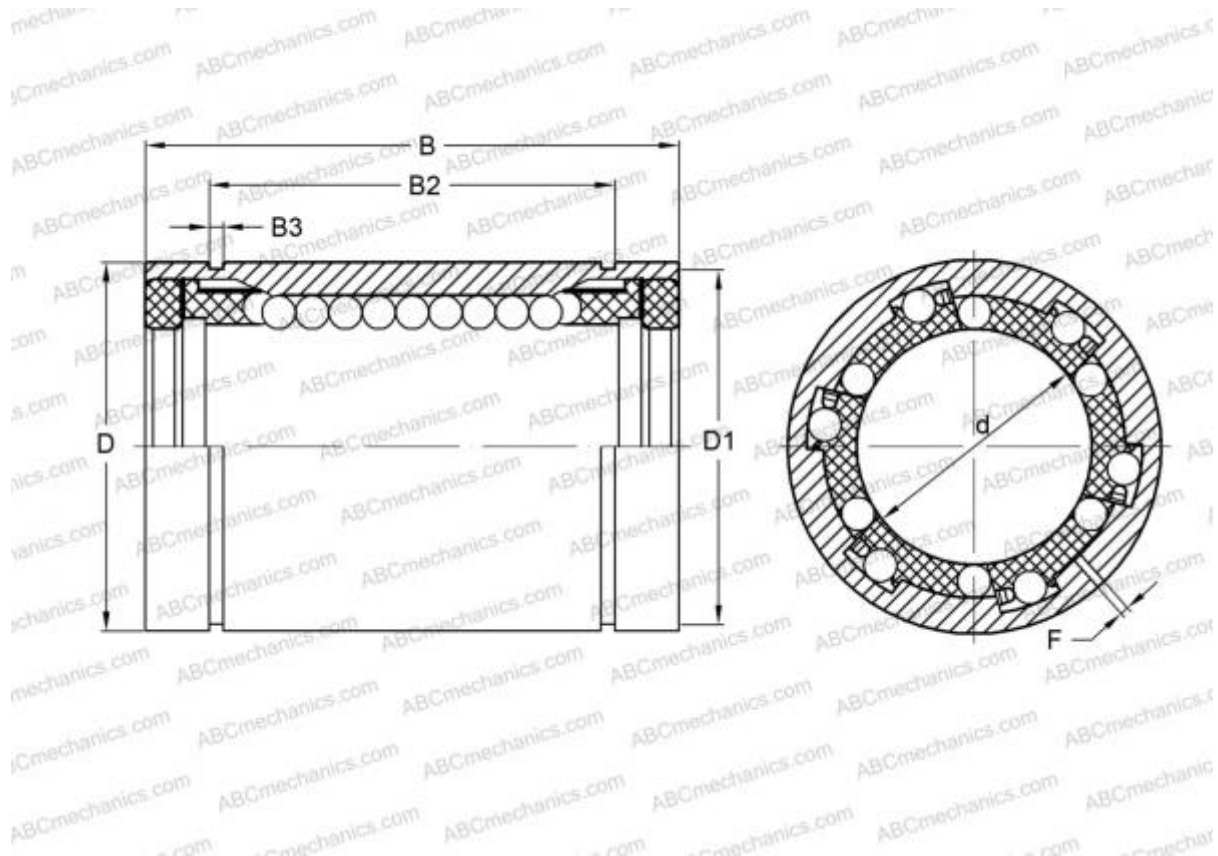

### Technical specification

#### DIMENSIONS, MM

d	25,000
D	40,000
B	58,000
f	2,000

**WEIGHT, KG** 0,235

**MANUFACTURER** [STAR](#)

#### INTERCHANGE

ABC	<a href="#">LME 254058 UU AJ</a>
IKO	<a href="#">LME 254058 UU AJ</a>
THOMSON	<a href="#">0612-025-10</a>