

0612-030-10 STAR

Linear bushing

TYPE: Shaft guidance systems, Linear bushing, Standard, Adjustable type, Type LME..(N) UU AJ, sealed on both sides

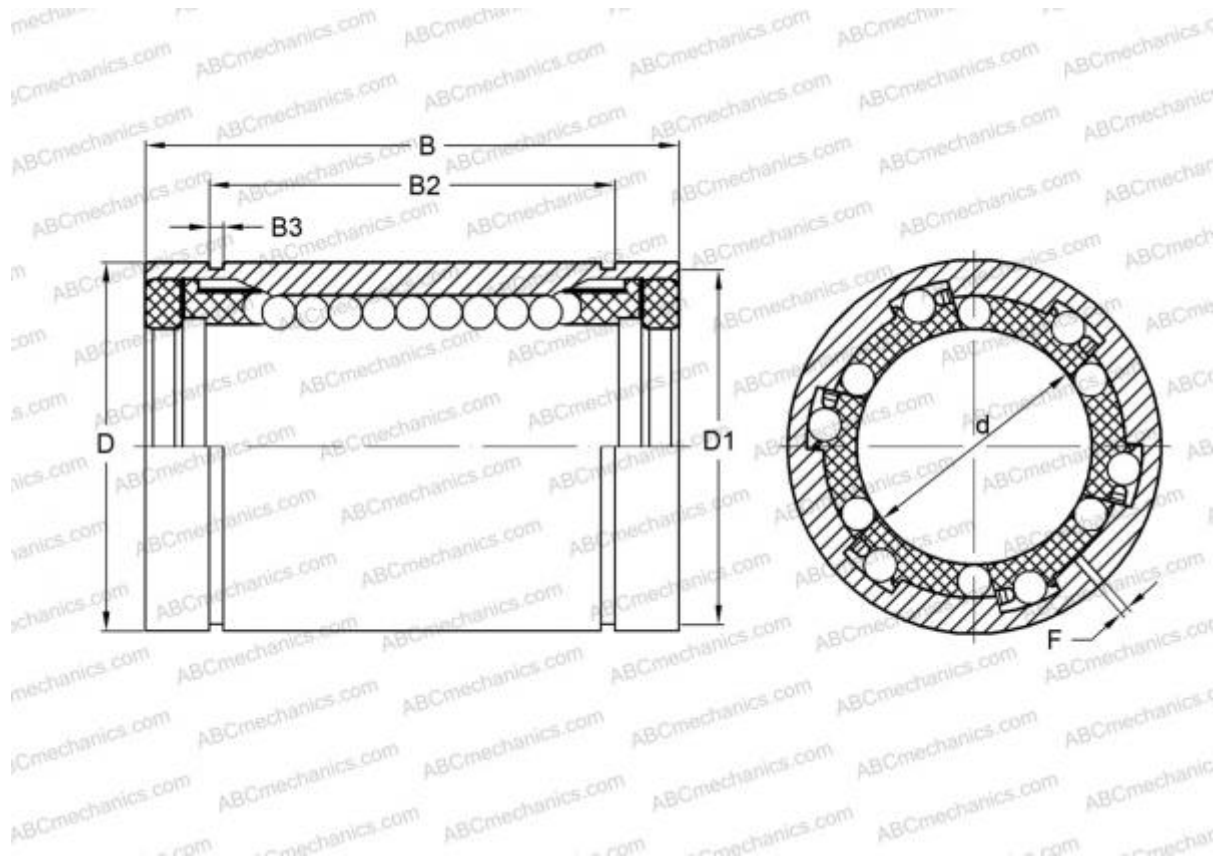

Technical specification

DIMENSIONS, MM

d	30,000
D	47,000
B	68,000
f	2,000

WEIGHT, KG 0,355

MANUFACTURER [STAR](#)

INTERCHANGE

ABC	LME 304768 UU AJ
IKO	LME 304768 UU AJ
THOMSON	0612-030-10