

## 0632-012-00 THOMSON

Linear bushing

TYPE: Shaft guidance systems, Linear bushing, Standard, Open type for support rail, Type LME..(N) UU OP, sealed on both sides

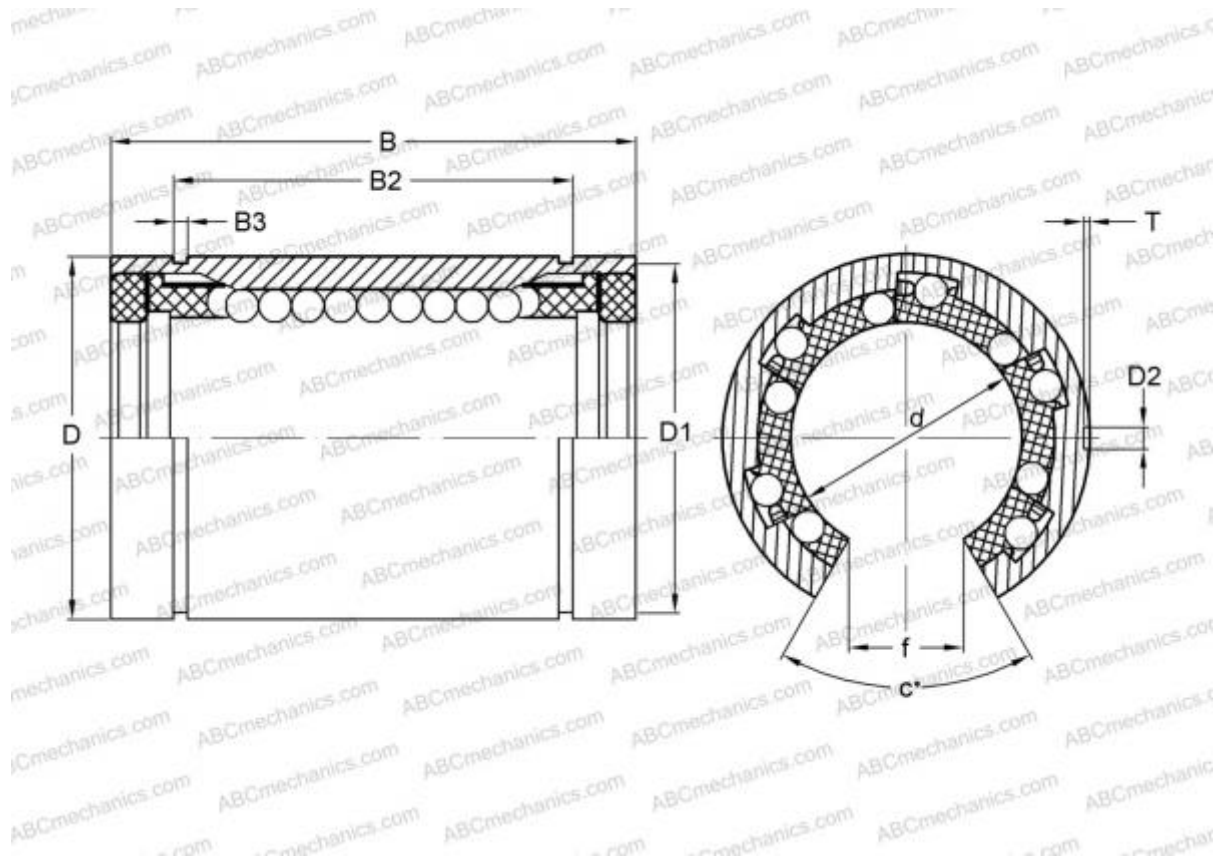

### Technical specification

#### DIMENSIONS, MM

d	12,000
D	22,000
B	32,000
f	7,500
c	78

**WEIGHT, KG** 0,035

**MANUFACTURER** [THOMSON](#)

#### INTERCHANGE

ABC	<a href="#">LME 122232 UU OP</a>
IKO	<a href="#">LME 122232 UU OP</a>
STAR	<a href="#">0632-012-00</a>