

0632-016-00 THOMSON

Linear bushing

TYPE: Shaft guidance systems, Linear bushing, Standard, Open type for support rail, Type LME..(N) UU OP, sealed on both sides

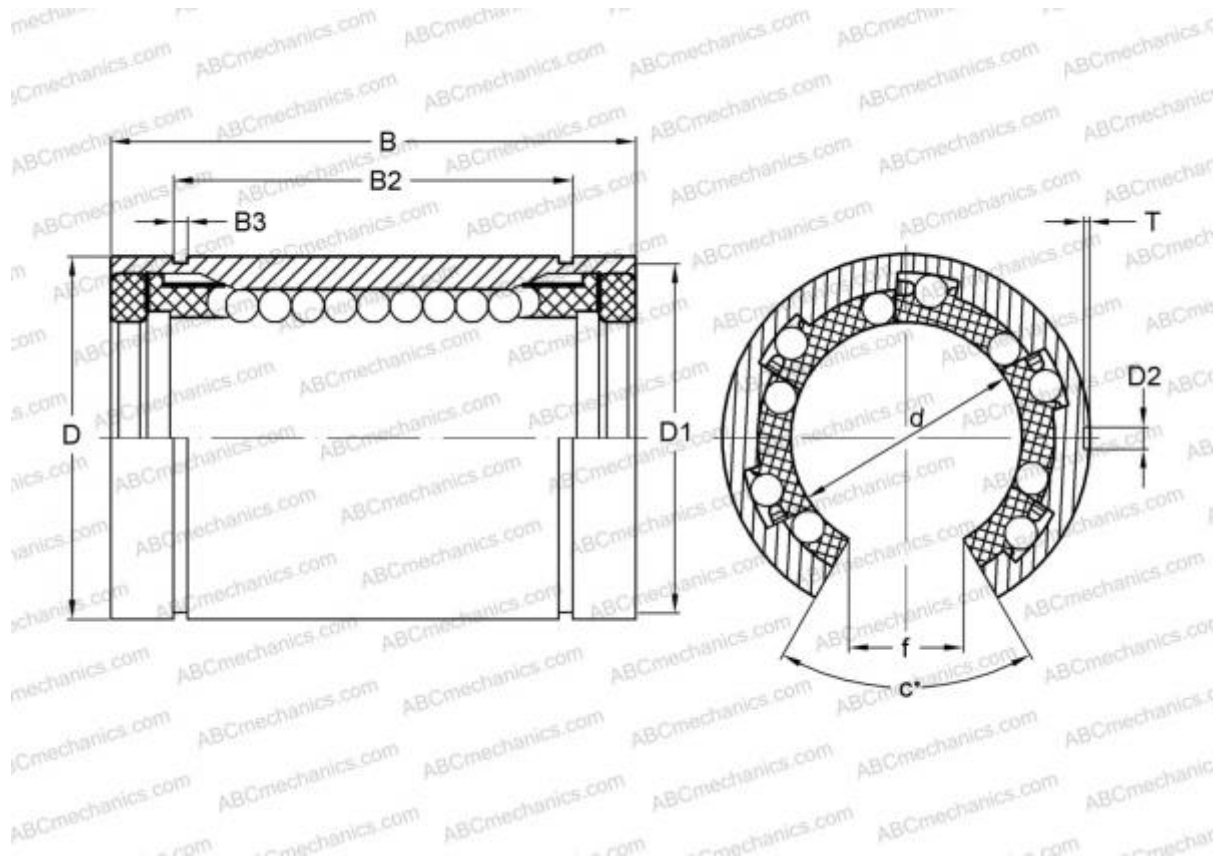

Technical specification

DIMENSIONS, MM

d	16,000
D	26,000
B	36,000
f	10,000
c	78

WEIGHT, KG 0,045

MANUFACTURER [THOMSON](#)

INTERCHANGE

ABC	LME 162636 UU OP
IKO	LME 162636 UU OP
STAR	0632-016-00