

## LME 162636 N UU OP ABC

Linear bushing

TYPE: Shaft guidance systems, Linear bushing, Standard, Open type for support rail, Type LME..(N) UU OP, sealed on both sides

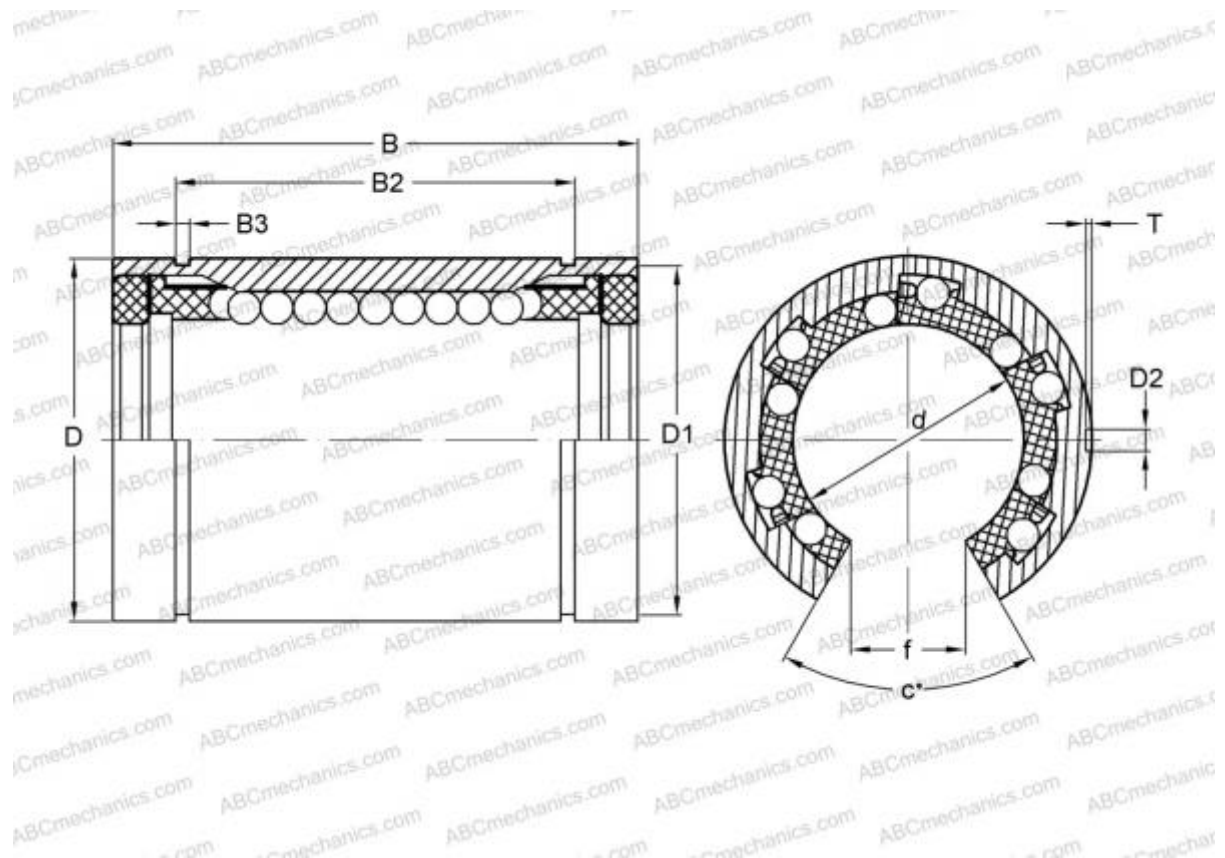

### Technical specification

#### DIMENSIONS, MM

d	16,000
D	26,000
B	36,000
f	10,000
c	78

**WEIGHT, KG** 0,044

**MANUFACTURER** [ABC](#)

#### INTERCHANGE

IKO	<a href="#">LME 162636 N UU OP</a>
INA	<a href="#">KBO 1636 PP</a>
SKF	<a href="#">LBCT 16-2LS</a>
FAG	<a href="#">LAN 16X26X36.2RS</a>