

## SMS 30-OP NB

Linear bushing

TYPE: Shaft guidance systems, Linear bushing, Standard, Open type for support rail, Type SM..OP, Asian standard, Corrosion resistance, Stainless steel cage (NB)

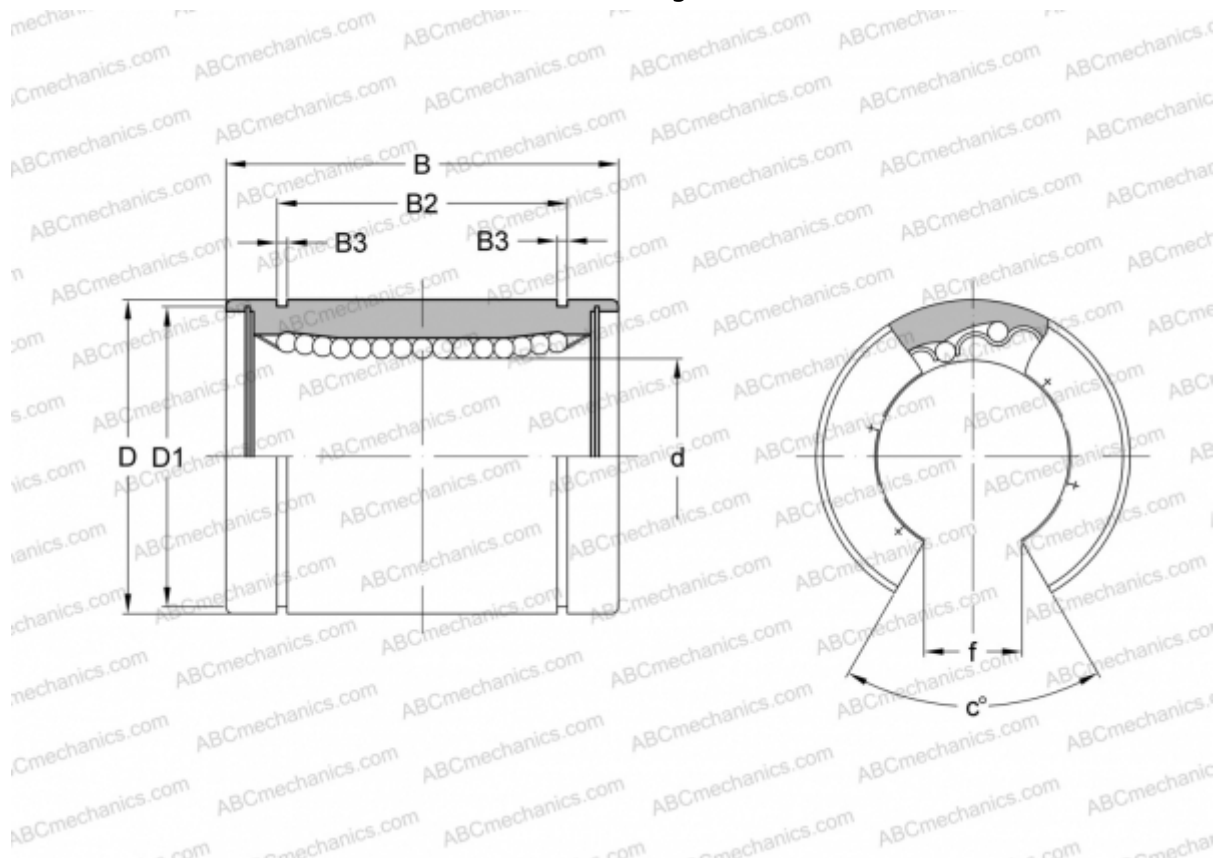

### Technical specification

#### DIMENSIONS, MM

d	30,000
D	45,000
B	64,000
D1	43,000
B2	44,500
B3	1,850
f	15,000
c	50

**WEIGHT, KG** 0,228

**MANUFACTURER** [NB](#)