

LME 254058 UU OP ABC

Linear bushing

TYPE: Shaft guidance systems, Linear bushing, Standard, Open type for support rail, Type LME..(N) UU OP, sealed on both sides

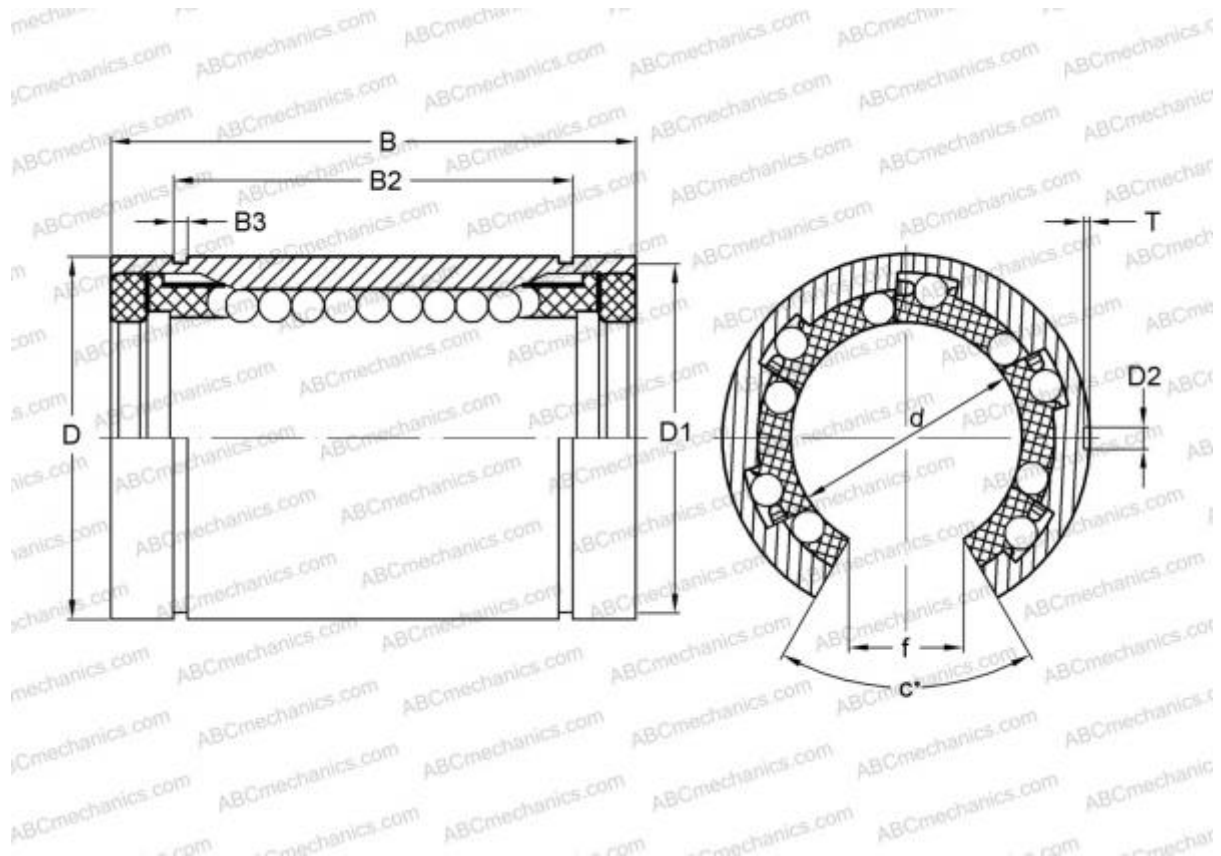

Technical specification

DIMENSIONS, MM

d	25,000
D	40,000
B	58,000
f	12,500
c	60,000

WEIGHT, KG 0,200

MANUFACTURER [ABC](#)

INTERCHANGE

IKO	LME 254058 UU OP
STAR	0632-025-00
THOMSON	0632-025-00