

LAN 25X 40X 58.2RS FAG

Linear bushing

TYPE: Shaft guidance systems, Linear bushing, Standard, Open type for support rail, Type LME..(N) UU OP, sealed on both sides

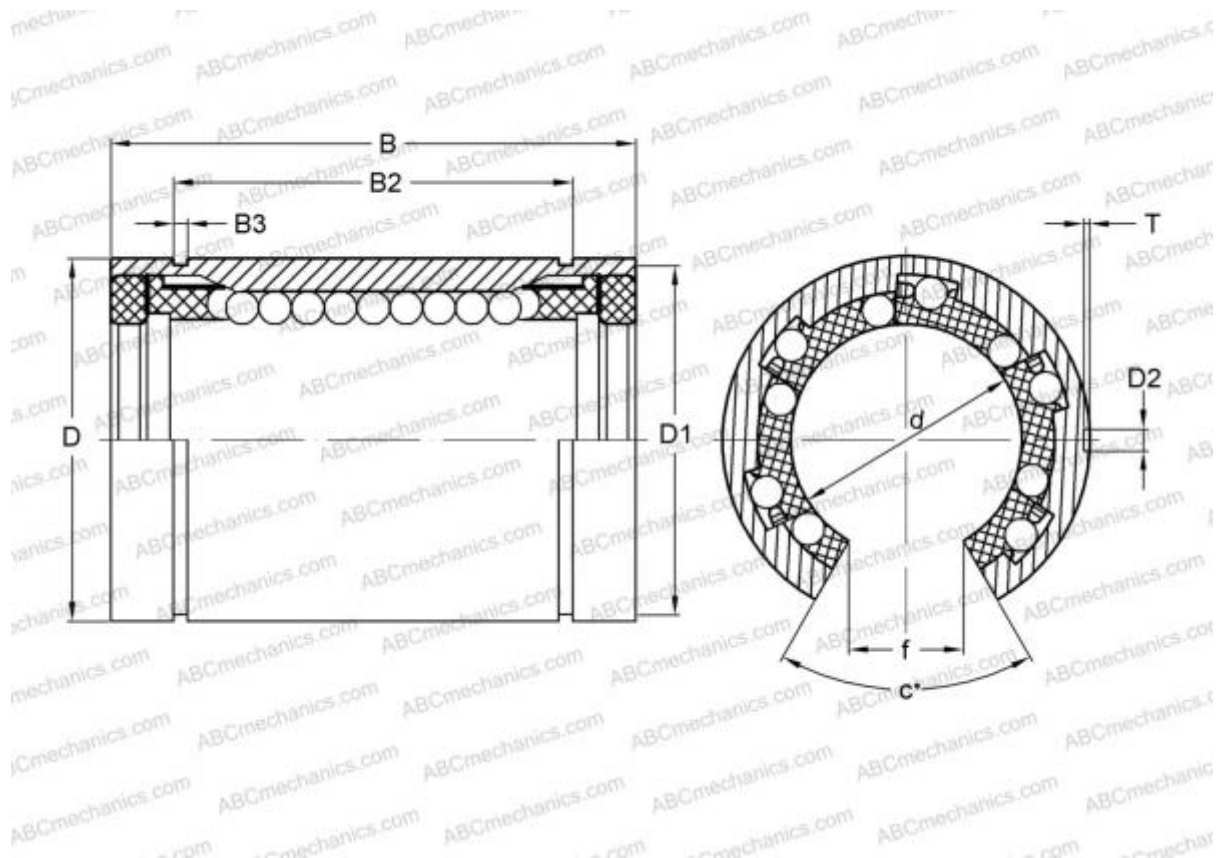

Technical specification

DIMENSIONS, MM

d	25,000
D	40,000
B	58,000
f	12,500
c	60

WEIGHT, KG 0,181

MANUFACTURER [FAG](#)

INTERCHANGE

ABC	LME 254058 N UU OP
IKO	LME 254058 N UU OP
INA	KBO 2558 PP
SKF	LBCT 25-2LS