

LME 304768 UU OP IKO

Linear bushing

TYPE: Shaft guidance systems, Linear bushing, Standard, Open type for support rail, Type LME..(N) UU OP, sealed on both sides

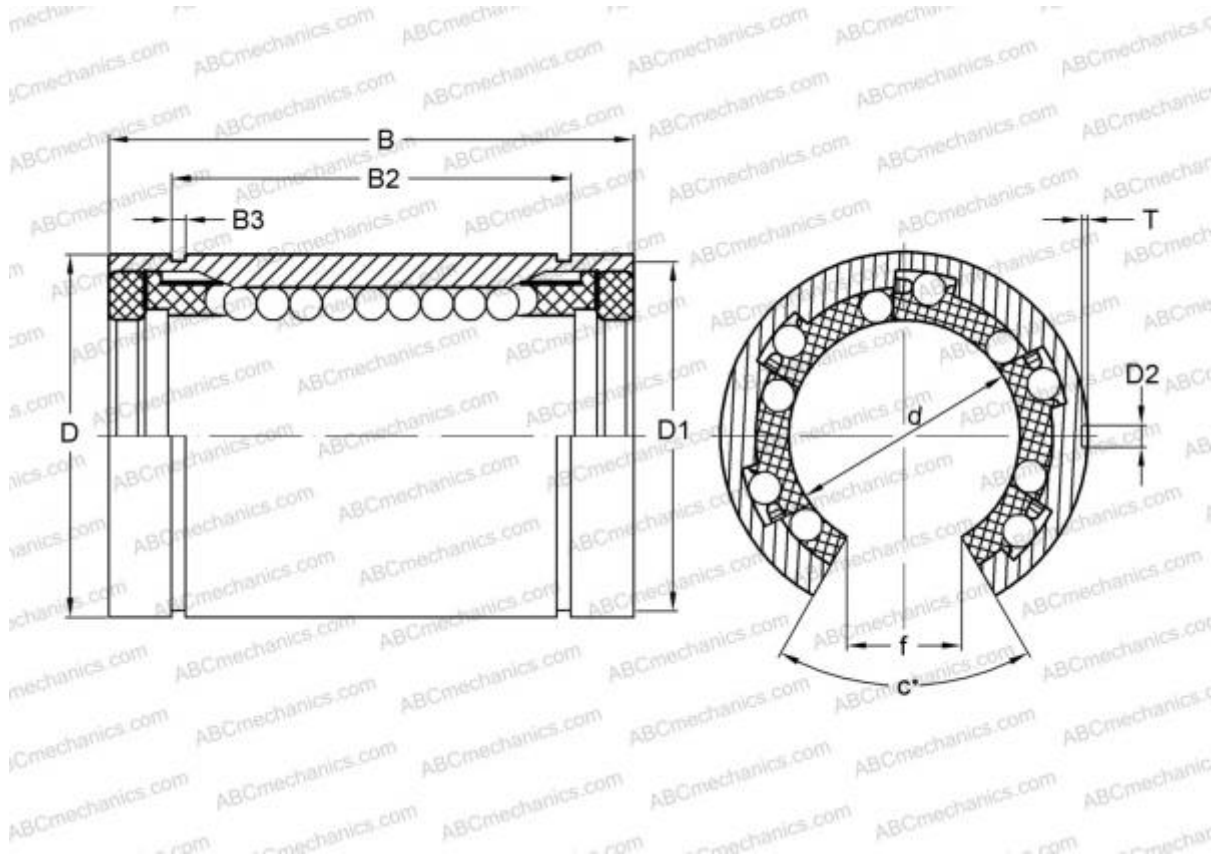

Technical specification

DIMENSIONS, MM

d	30,000
D	47,000
B	68,000
f	12,500
c	50,000

WEIGHT, KG 0,300

MANUFACTURER [IKO](#)

INTERCHANGE

ABC	LME 304768 UU OP
STAR	0632-030-00
THOMSON	0632-030-00

CALCULATION DATA

Basic dynamic load rating min	1,350 kN
-------------------------------	----------

CALCULATION DATA

Basic dynamic load rating max	1,430 kN
Basic static load rating min	2,500 kN
Basic static load rating max	3,200 kN