

0632-030-00 STAR

Linear bushing

TYPE: Shaft guidance systems, Linear bushing, Standard, Open type for support rail, Type LME..(N) UU OP, sealed on both sides

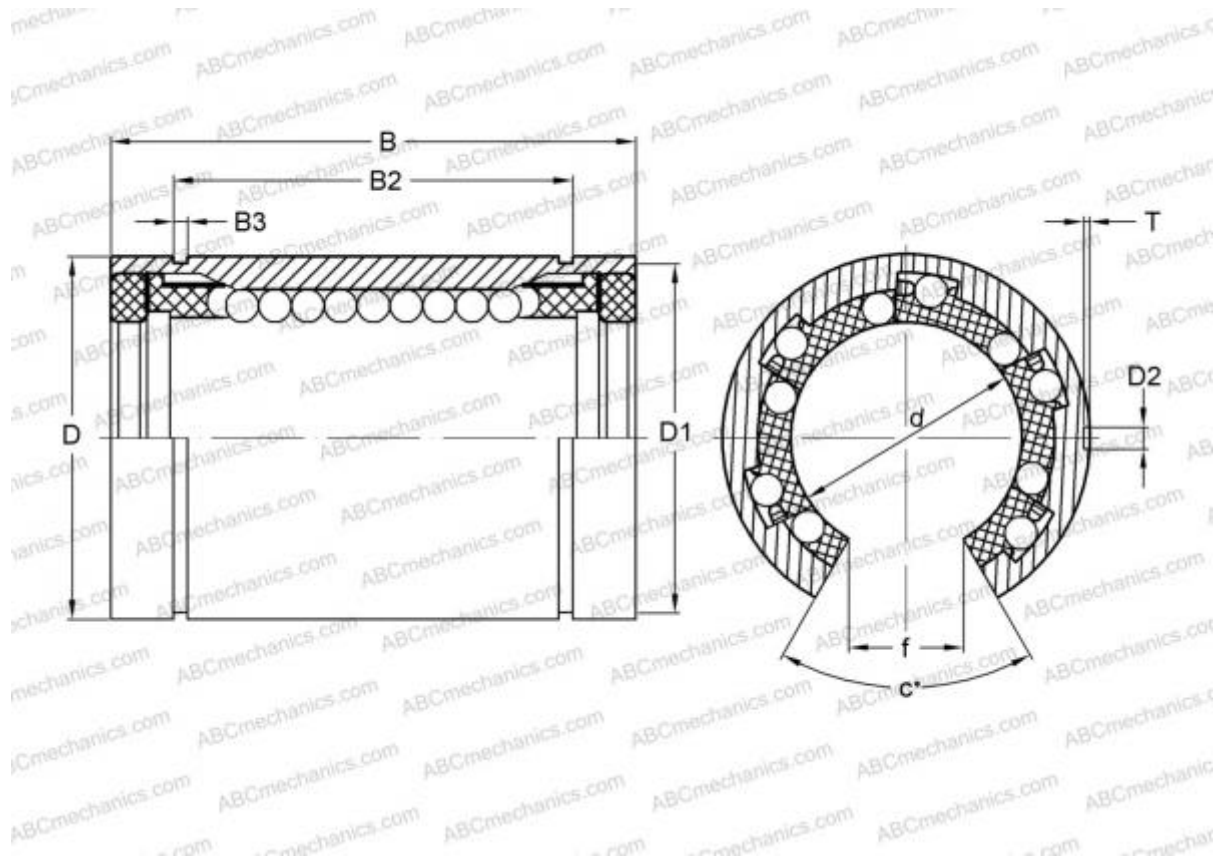

Technical specification

DIMENSIONS, MM

d	30,000
D	47,000
B	68,000
f	12,500
c	50

WEIGHT, KG 0,300

MANUFACTURER [STAR](#)

INTERCHANGE

ABC	LME 304768 UU OP
IKO	LME 304768 UU OP
THOMSON	0632-030-00