

LME 12232 N F IKO

Linear bushing

TYPE: Shaft guidance systems, Linear bushing, Standard, Close type, Type LME..(N) F, stainless steel (IKO)

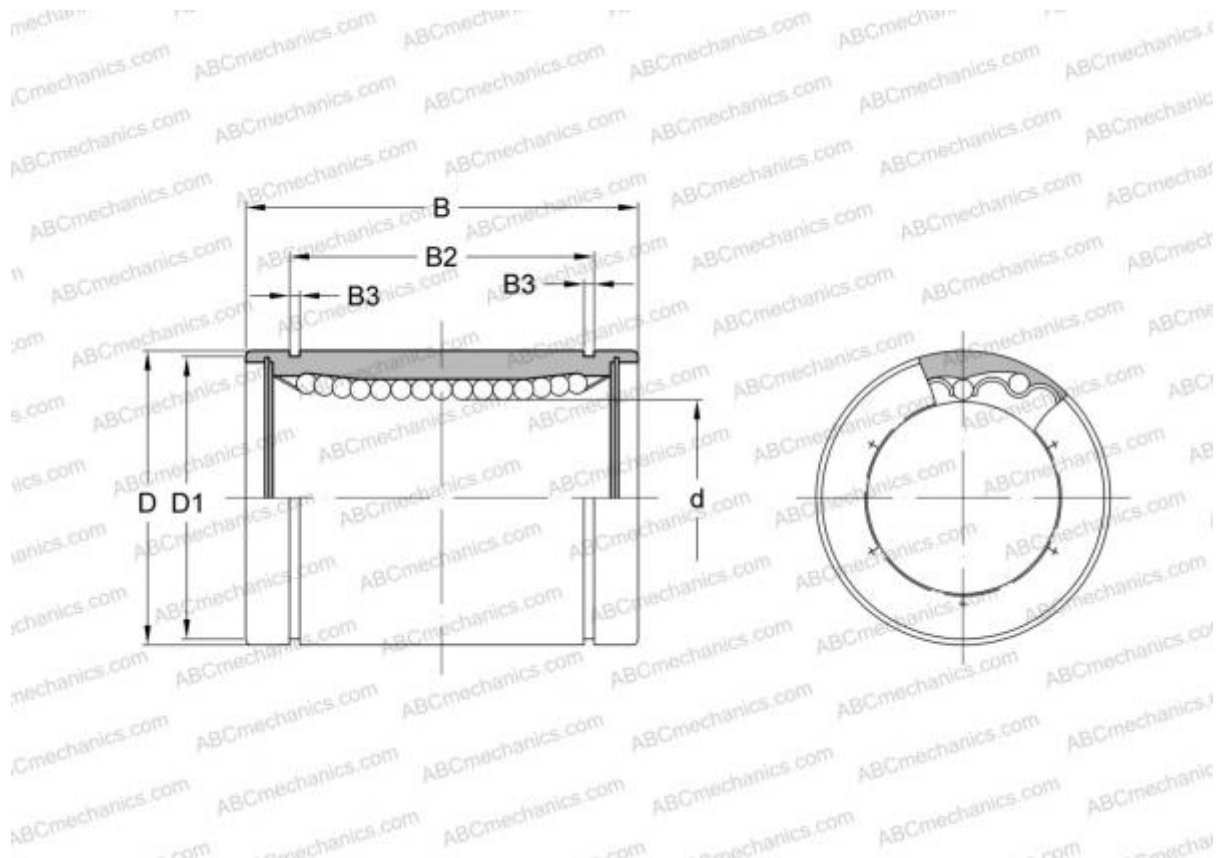

Technical specification

DIMENSIONS, MM

d	12,000
D	22,000
B	32,000

WEIGHT, KG 0,041

MANUFACTURER [IKO](#)

CALCULATION DATA

Basic dynamic load rating min	0,259 kN
Basic dynamic load rating max	0,298 kN
Basic static load rating min	0,503 kN
Basic static load rating max	0,711 kN