

## LME 254058 F IKO

Linear bushing

TYPE: Shaft guidance systems, Linear bushing, Standard, Close type, Type LME..(N) F, stainless steel (IKO)

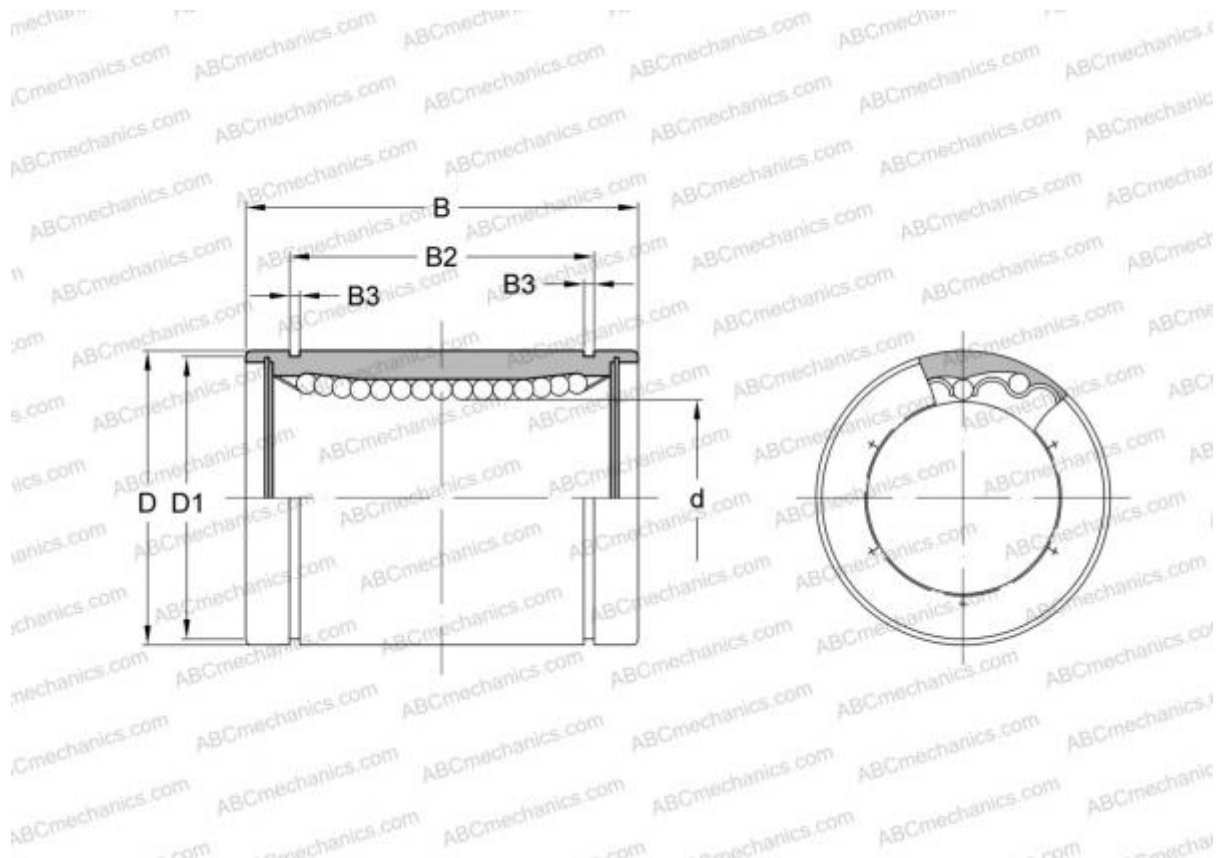

### Technical specification

#### DIMENSIONS, MM

d	25,000
D	40,000
B	58,000

**WEIGHT, KG** 0,240

**MANUFACTURER** [IKO](#)

#### CALCULATION DATA

Basic dynamic load rating min	0,920 kN
Basic dynamic load rating max	0,974 kN
Basic static load rating min	1,780 kN
Basic static load rating max	2,280 kN