

LME 162636 N F AJ IKO

Linear bushing

TYPE: Shaft guidance systems, Linear bushing, Standard, Adjustable type, Type LME..(N) AJ, stainless steel (IKO)

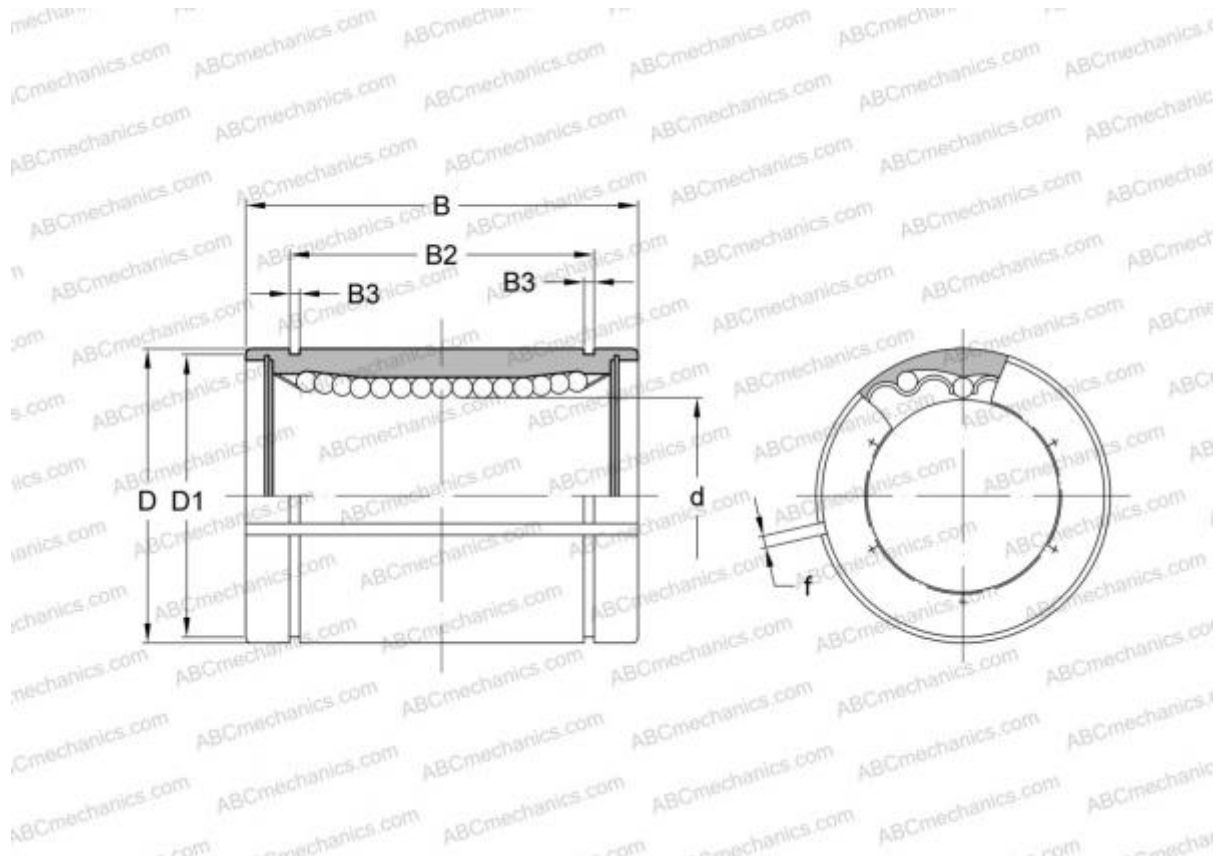

Technical specification

DIMENSIONS, MM

d	16,000
D	26,000
B	36,000
f	1,500

WEIGHT, KG 0,055

MANUFACTURER [IKO](#)

CALCULATION DATA

Basic dynamic load rating min	0,283 kN
Basic dynamic load rating max	0,325 kN
Basic static load rating min	0,514 kN
Basic static load rating max	0,726 kN