

LME 203245 N F AJ IKO

Linear bushing

TYPE: Shaft guidance systems, Linear bushing, Standard, Adjustable type, Type LME..(N) AJ, stainless steel (IKO)

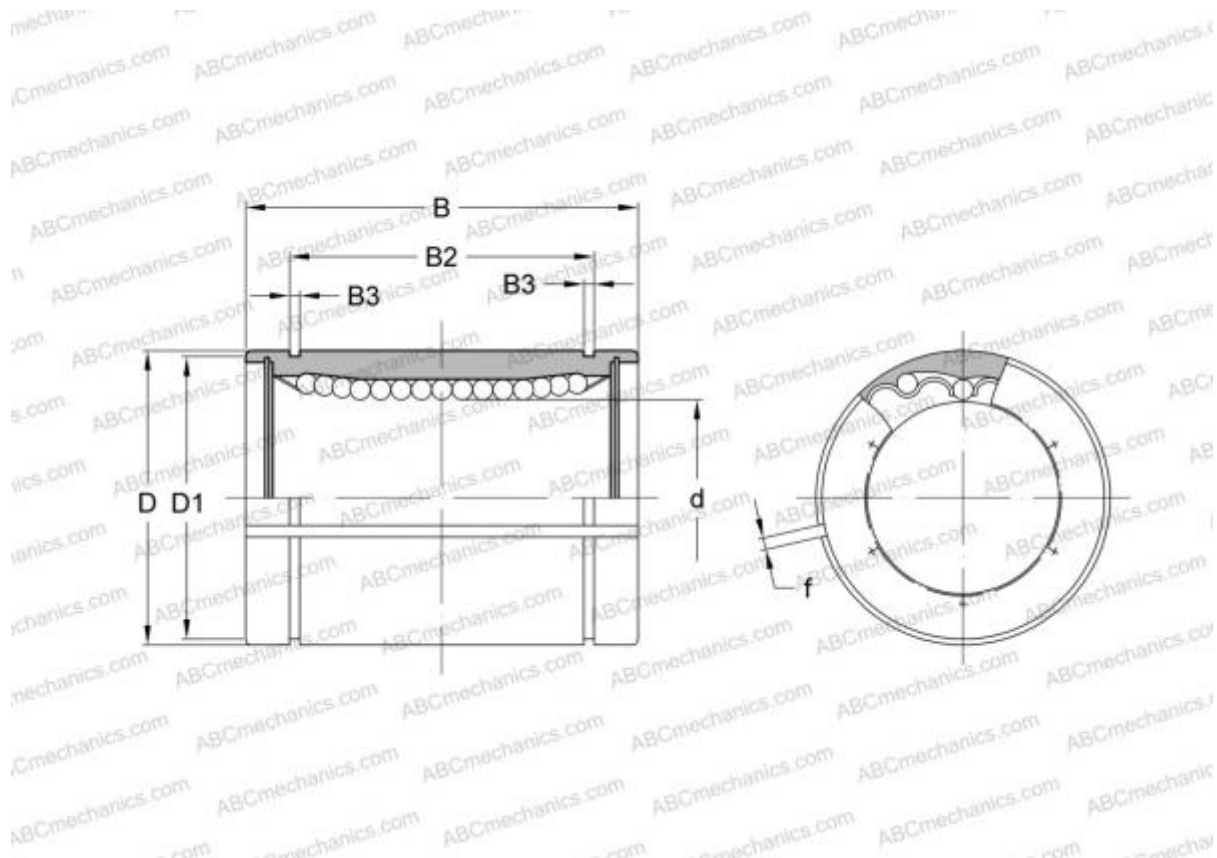

Technical specification

DIMENSIONS, MM

d	20,000
D	32,000
B	45,000
f	2,000

WEIGHT, KG 0,090

MANUFACTURER [IKO](#)

CALCULATION DATA

Basic dynamic load rating min	0,562 kN
Basic dynamic load rating max	0,668 kN
Basic static load rating min	1,010 kN
Basic static load rating max	1,470 kN