

## LME 304768 N F AJ IKO

Linear bushing

TYPE: Shaft guidance systems, Linear bushing, Standard, Adjustable type, Type LME..(N) AJ, stainless steel (IKO)

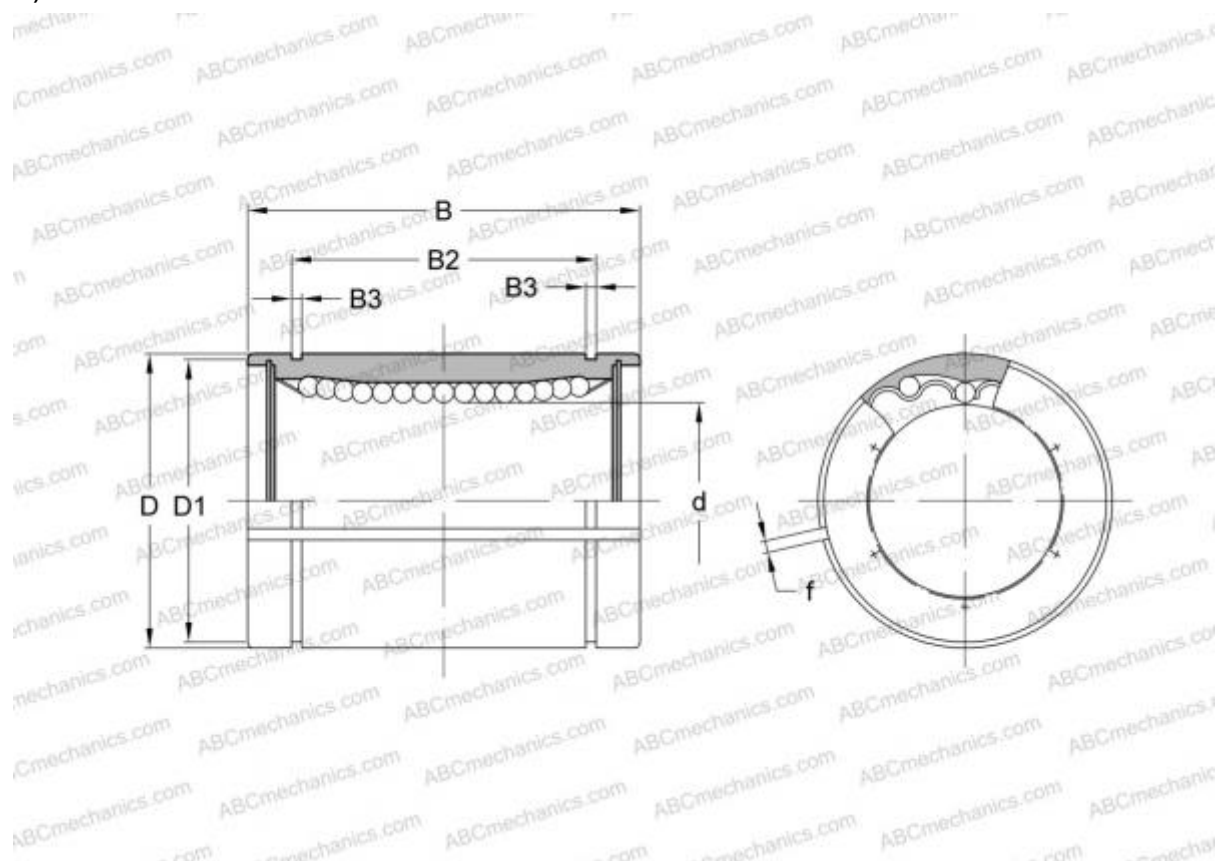

### Technical specification

#### DIMENSIONS, MM

d	30,000
D	47,000
B	68,000
f	2,000

**WEIGHT, KG** 0,320

**MANUFACTURER** [IKO](#)

#### CALCULATION DATA

Basic dynamic load rating min	1,350 kN
Basic dynamic load rating max	1,430 kN
Basic static load rating min	2,500 kN
Basic static load rating max	3,200 kN