

LME 254058 F OP IKO

Linear bushing

TYPE: Shaft guidance systems, Linear bushing, Standard, Open type for support rail, Type LME..(N) F OP, stainless steel (IKO)

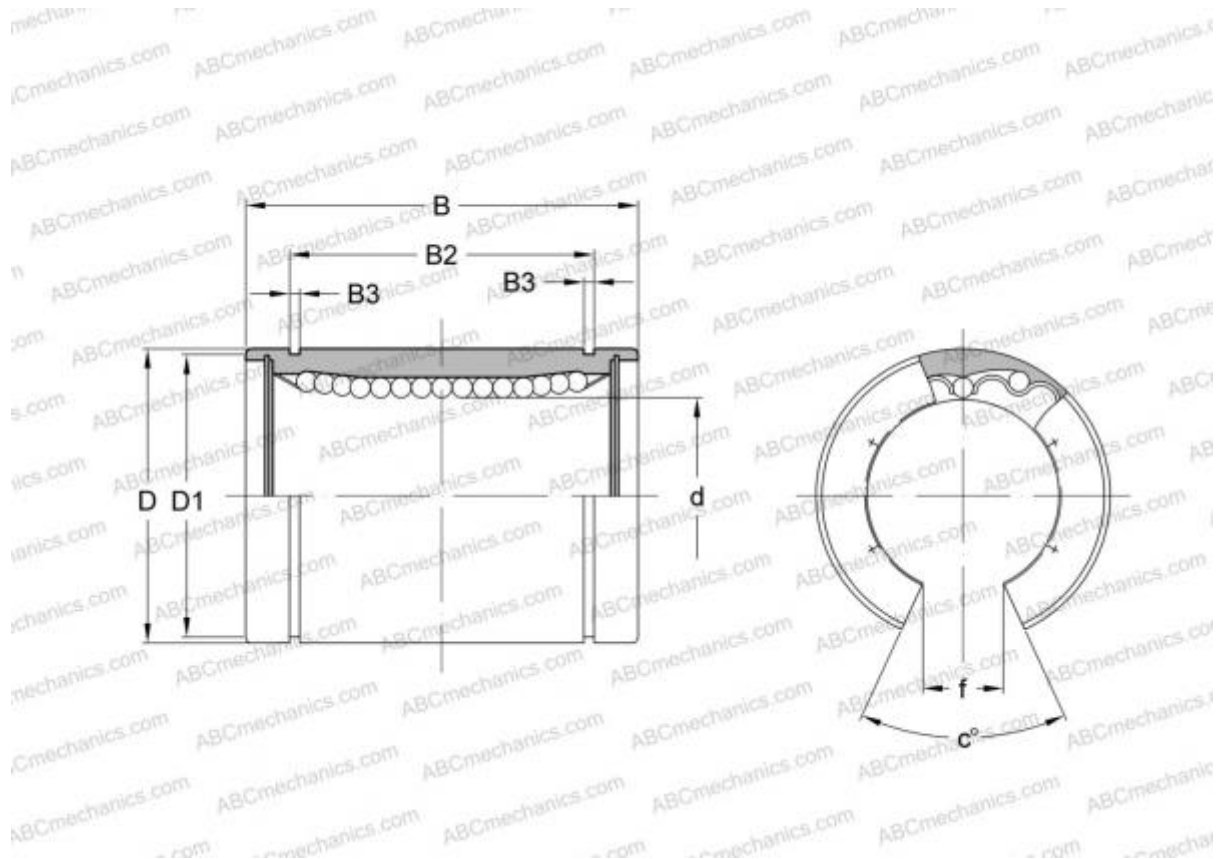

Technical specification

DIMENSIONS, MM

d	25,000
D	40,000
B	58,000
f	12,500
c	60,000

WEIGHT, KG 0,240

MANUFACTURER [IKO](#)

CALCULATION DATA

Basic dynamic load rating min	0,920 kN
Basic dynamic load rating max	0,974 kN
Basic static load rating min	1,780 kN
Basic static load rating max	2,280 kN