

SMS 25G-OP NB

Linear bushing

TYPE: Shaft guidance systems, Linear bushing, Standard, Open type for support rail, Type SM..OP, Asian standard, Corrosion resistance, Plastic cage (NB)

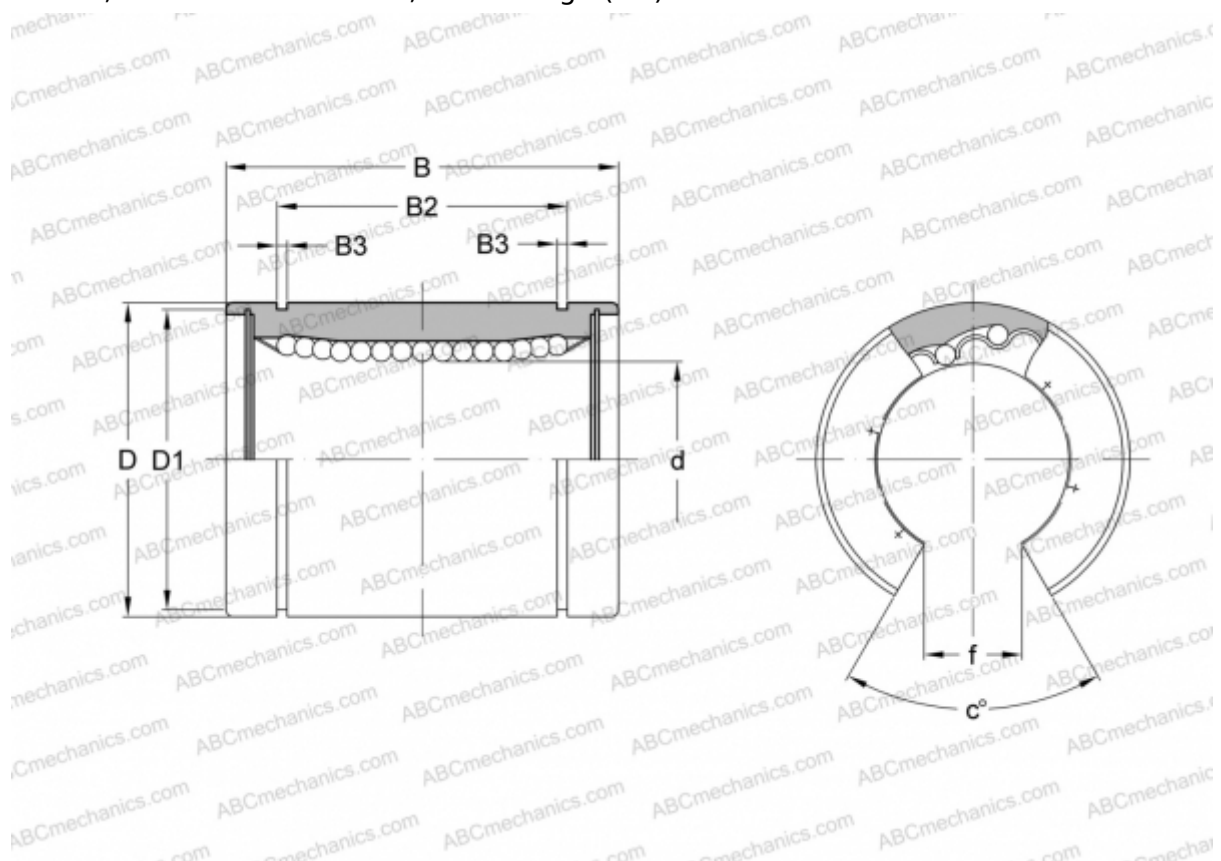

Technical specification

DIMENSIONS, MM

d	25,000
D	40,000
B	59,000
D1	38,000
B2	41,000
B3	1,850
f	12,000
c	50

WEIGHT, KG 0,203

MANUFACTURER [NB](#)