

SMS 30G-OP NB

Linear bushing

TYPE: Shaft guidance systems, Linear bushing, Standard, Open type for support rail, Type SM..OP, Asian standard, Corrosion resistance, Plastic cage (NB)

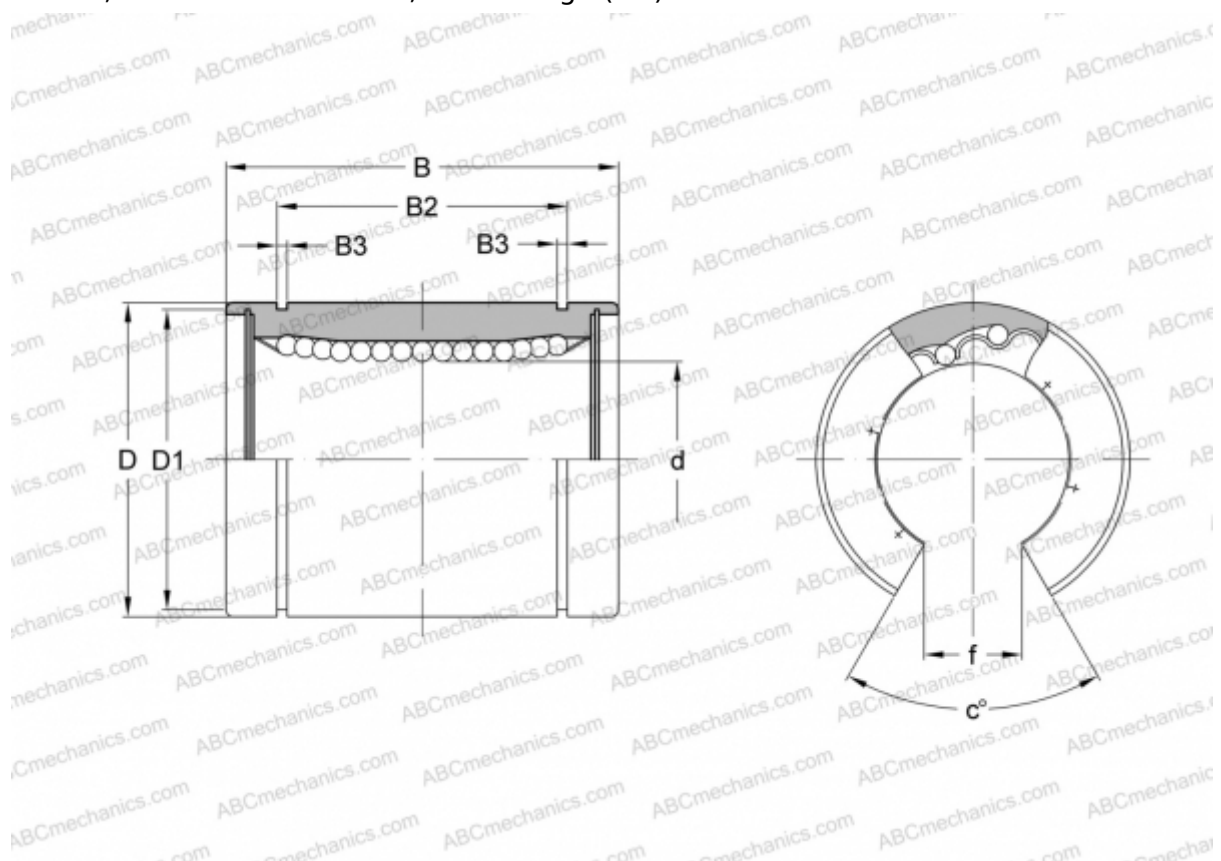

Technical specification

DIMENSIONS, MM

d	30,000
D	45,000
B	64,000
D1	43,000
B2	44,500
B3	1,850
f	15,000
c	50

WEIGHT, KG 0,228

MANUFACTURER [NB](#)