

LME 203245 N F UU OP IKO

Linear bushing

TYPE: Shaft guidance systems, Linear bushing, Standard, Open type for support rail, Type LME..(N) F UU OP, stainless steel, sealed on both sides (IKO)

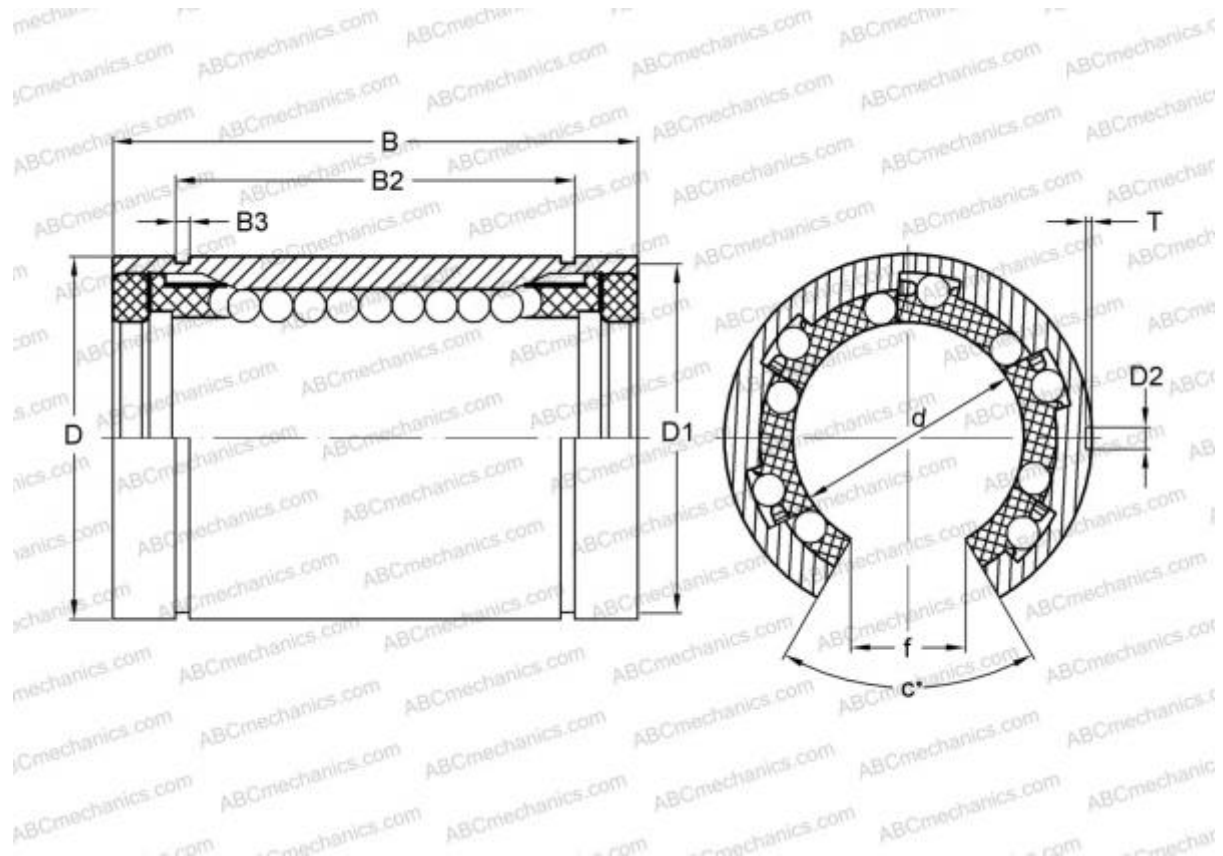

Technical specification

DIMENSIONS, MM

d	20,000
D	32,000
B	45,000
f	10,000
c	60

WEIGHT, KG 0,075

MANUFACTURER [IKO](#)

CALCULATION DATA

Basic dynamic load rating min	0,562 kN
Basic dynamic load rating max	0,668 kN
Basic static load rating min	1,010 kN
Basic static load rating max	1,470 kN