

4812 SCHNEEBERGER

Linear bushing

TYPE: Shaft guidance systems, Linear bushing, Standard, Close type, Type LMB..(N), inch

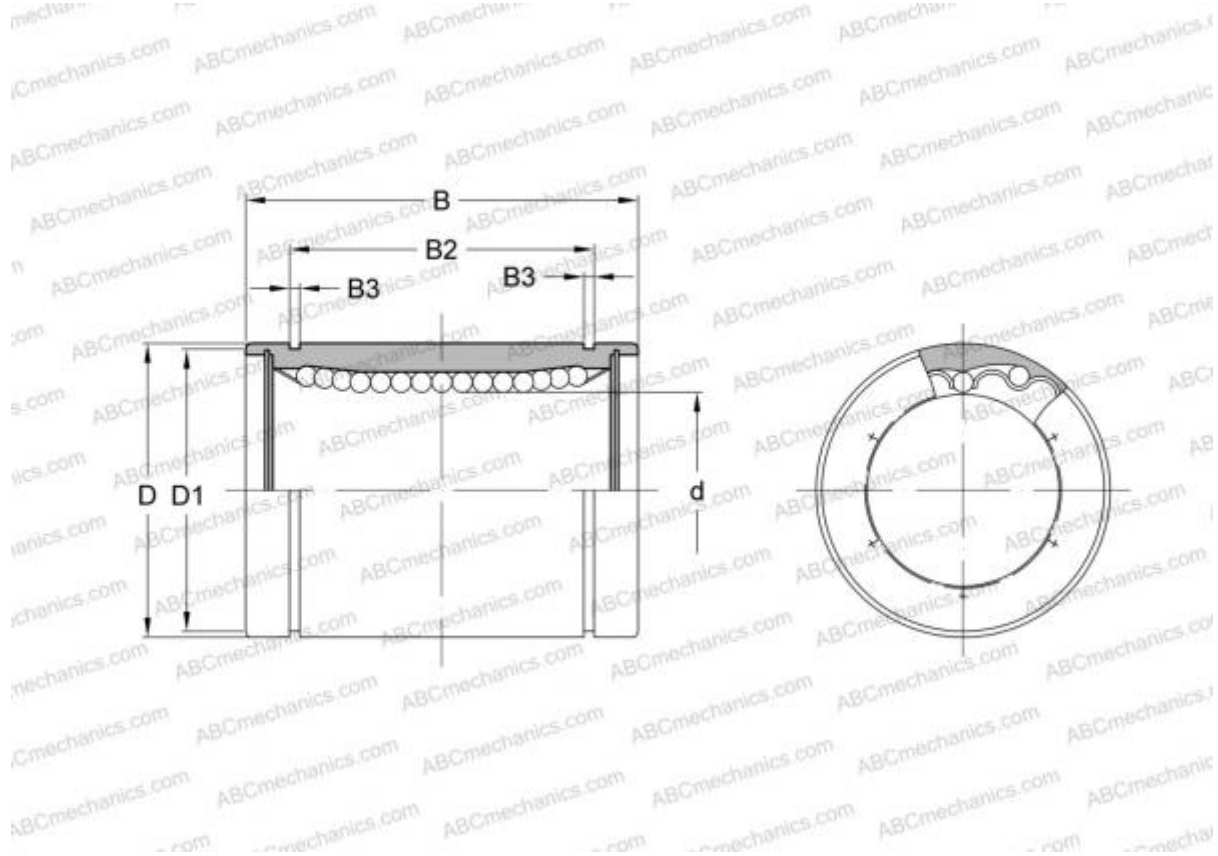

Technical specification

DIMENSIONS, MM

d	6,350
D	12,700
B	19,050

WEIGHT, KG 0,009

MANUFACTURER [SCHNEEBERGER](#)

INTERCHANGE

ABC	LMB 4812
IKO	LMB 4812
THOMSON	A-4812