

LMB 61014 IKO

Linear bushing

TYPE: Shaft guidance systems, Linear bushing, Standard, Close type, Type LMB..(N), inch

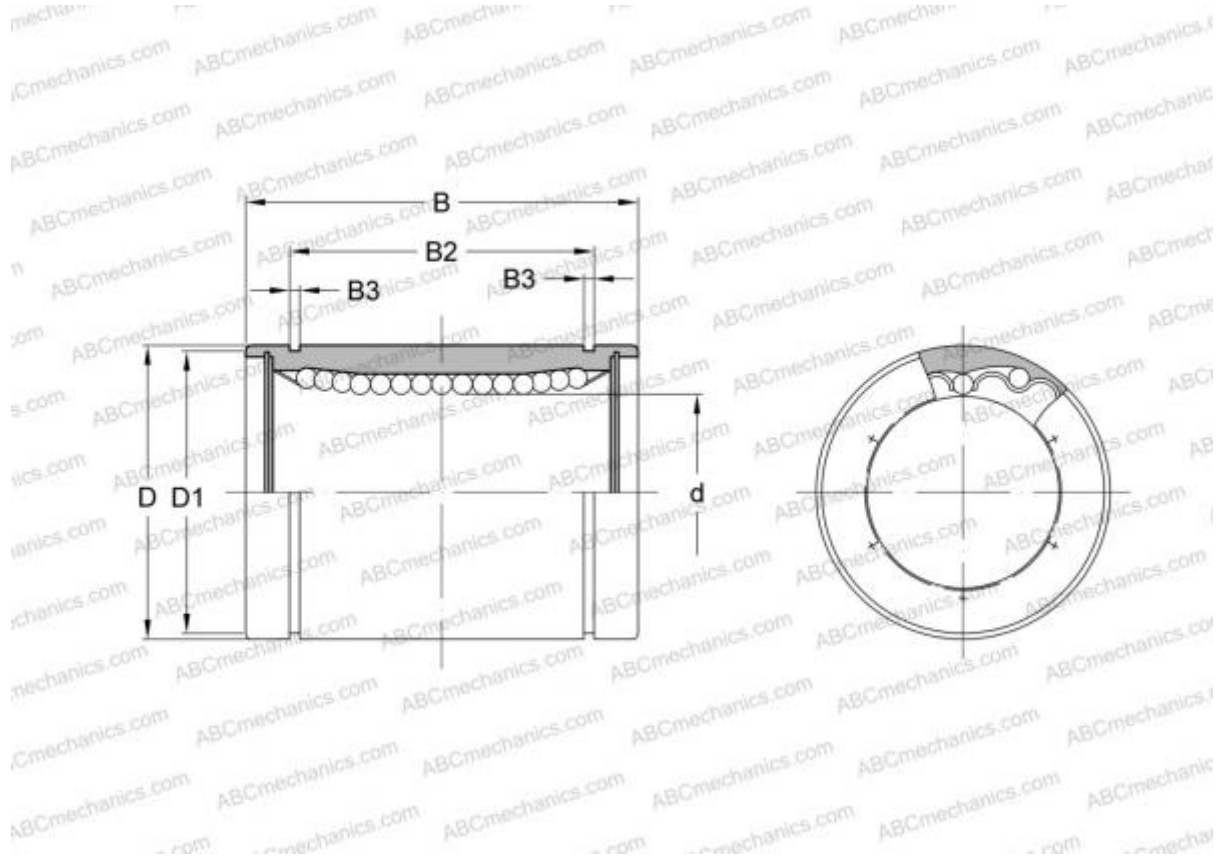

Technical specification

DIMENSIONS, MM

d	9,525
D	15,875
B	22,225

WEIGHT, KG 0,028

MANUFACTURER [IKO](#)

INTERCHANGE

ABC	LMB 61014
THOMSON	A-61014
SCHNEEBERGER	61014

CALCULATION DATA

Basic dynamic load rating min	0,095 kN
Basic dynamic load rating max	0,109 kN
Basic static load rating min	0,174 kN

CALCULATION DATA

Basic static load rating max	0,246 kN
------------------------------	----------