

## 122026 SCHNEEBERGER

Linear bushing

TYPE: Shaft guidance systems, Linear bushing, Standard, Close type, Type LMB..(N), inch

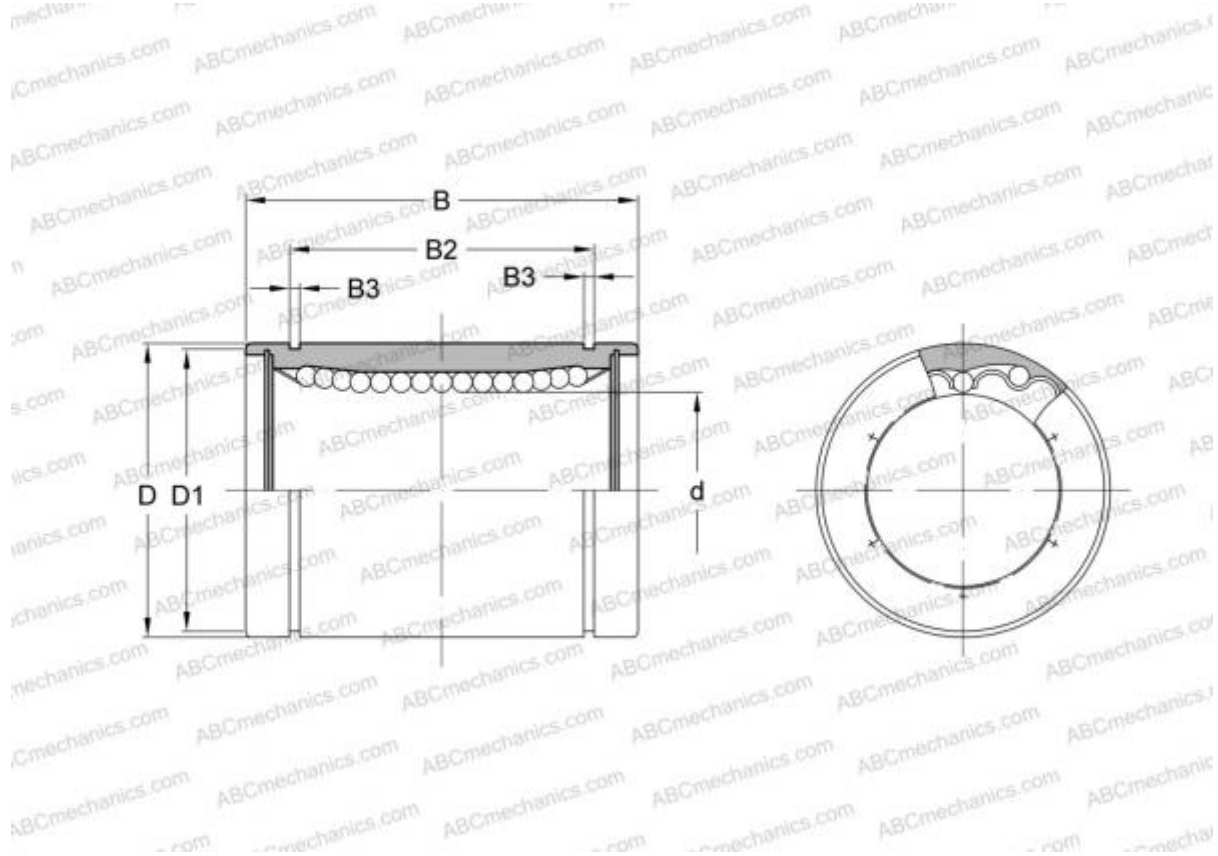

### Technical specification

#### DIMENSIONS, MM

d	19,050
D	31,750
B	41,275

**WEIGHT, KG** 0,098

**MANUFACTURER** [SCHNEEBERGER](#)

#### INTERCHANGE

ABC	<a href="#">LMB 122026</a>
IKO	<a href="#">LMB 122026</a>
THOMSON	<a href="#">A-122026</a>