

## 324864 SCHNEEBERGER

Linear bushing

TYPE: Shaft guidance systems, Linear bushing, Standard, Close type, Type LMB..(N), inch

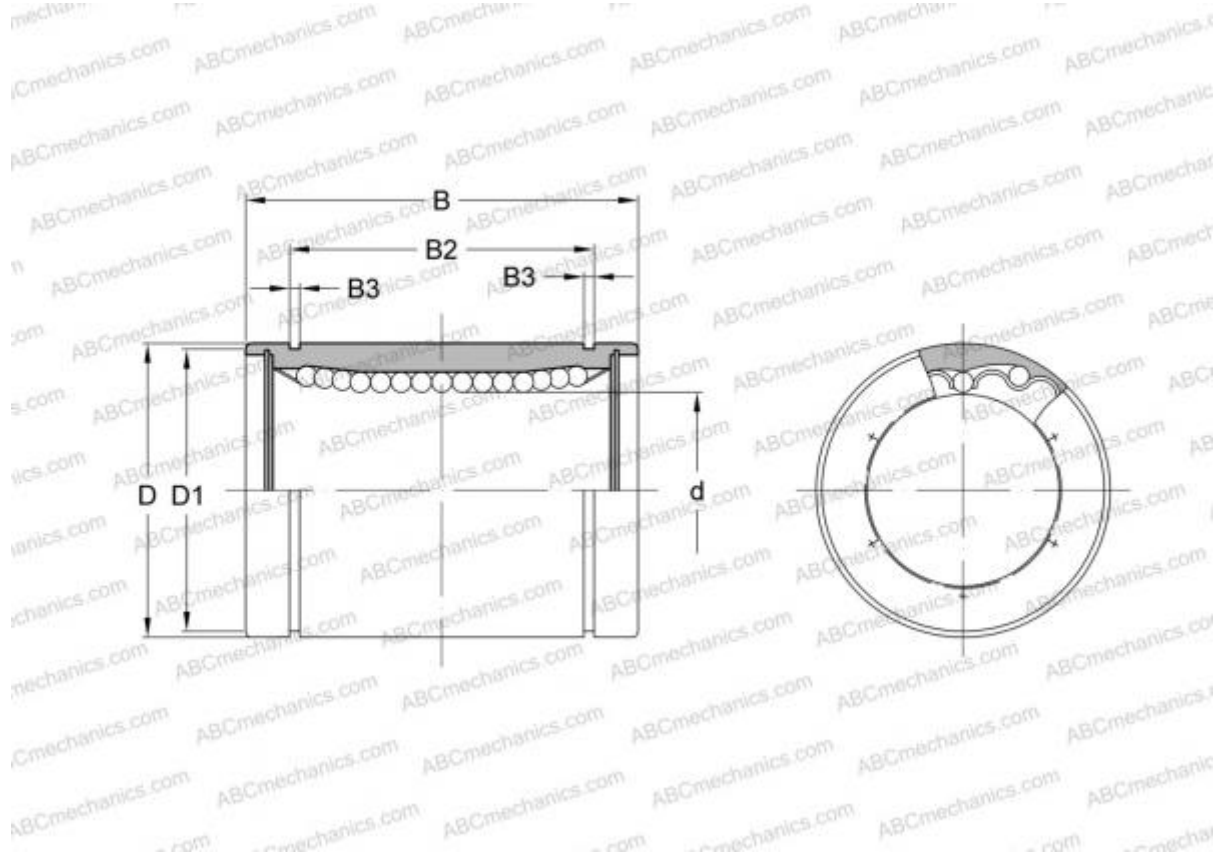

### Technical specification

#### DIMENSIONS, MM

d	50,800
D	76,200
B	101,600

**WEIGHT, KG** 1,530

**MANUFACTURER** [SCHNEEBERGER](#)

#### INTERCHANGE

ABC	<a href="#">LMB 324864</a>
IKO	<a href="#">LMB 324864</a>
THOMSON	<a href="#">A-324864</a>