

LMB 406080 IKO

Linear bushing

TYPE: Shaft guidance systems, Linear bushing, Standard, Close type, Type LMB..(N), inch

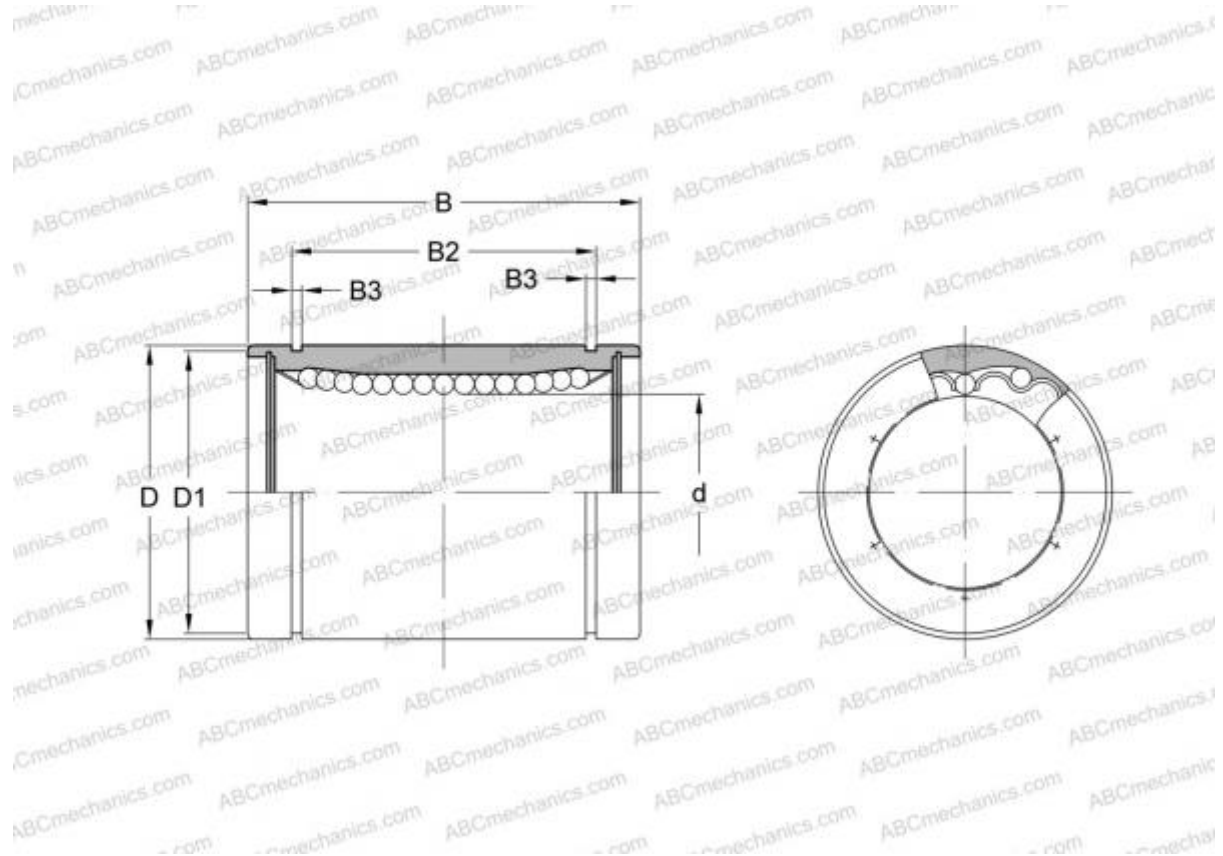

Technical specification

DIMENSIONS, MM

d	63,500
D	95,250
B	127,000

WEIGHT, KG 2,400

MANUFACTURER [IKO](#)

INTERCHANGE

ABC	LMB 406080
THOMSON	A-406080
SCHNEEBERGER	406080

CALCULATION DATA

Basic dynamic load rating min	5,190 kN
Basic dynamic load rating max	5,490 kN
Basic static load rating min	9,090 kN

CALCULATION DATA

Basic static load rating max	11,600 kN
------------------------------	-----------