

406080 SCHNEEBERGER

Linear bushing

TYPE: Shaft guidance systems, Linear bushing, Standard, Close type, Type LMB..(N), inch

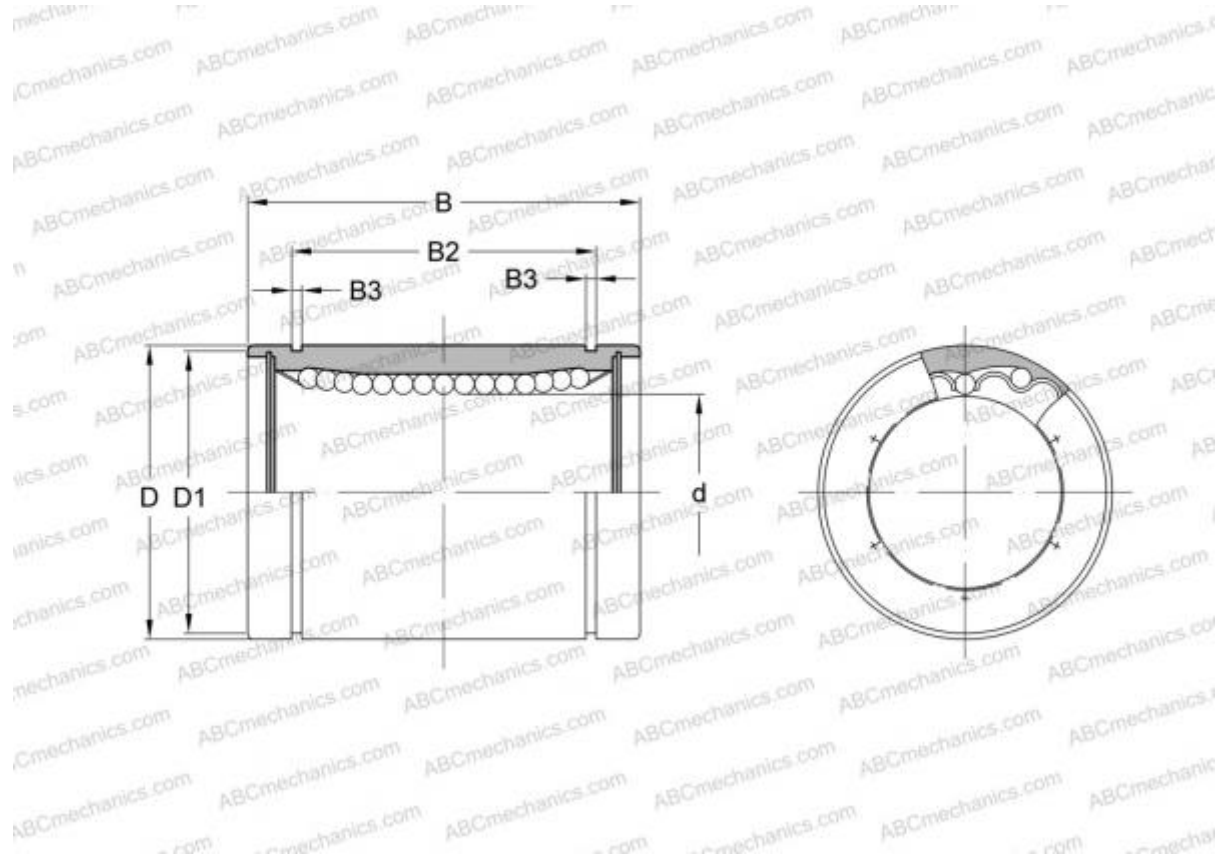

Technical specification

DIMENSIONS, MM

d	63,500
D	95,250
B	127,000

WEIGHT, KG 2,400

MANUFACTURER [SCHNEEBERGER](#)

INTERCHANGE

ABC	LMB 406080
IKO	LMB 406080
THOMSON	A-406080