

ADJ-1000 HEIM

Linear bushing

TYPE: Shaft guidance systems, Linear bushing, Standard, Adjustable type, Type LMB..(N) AJ, inch

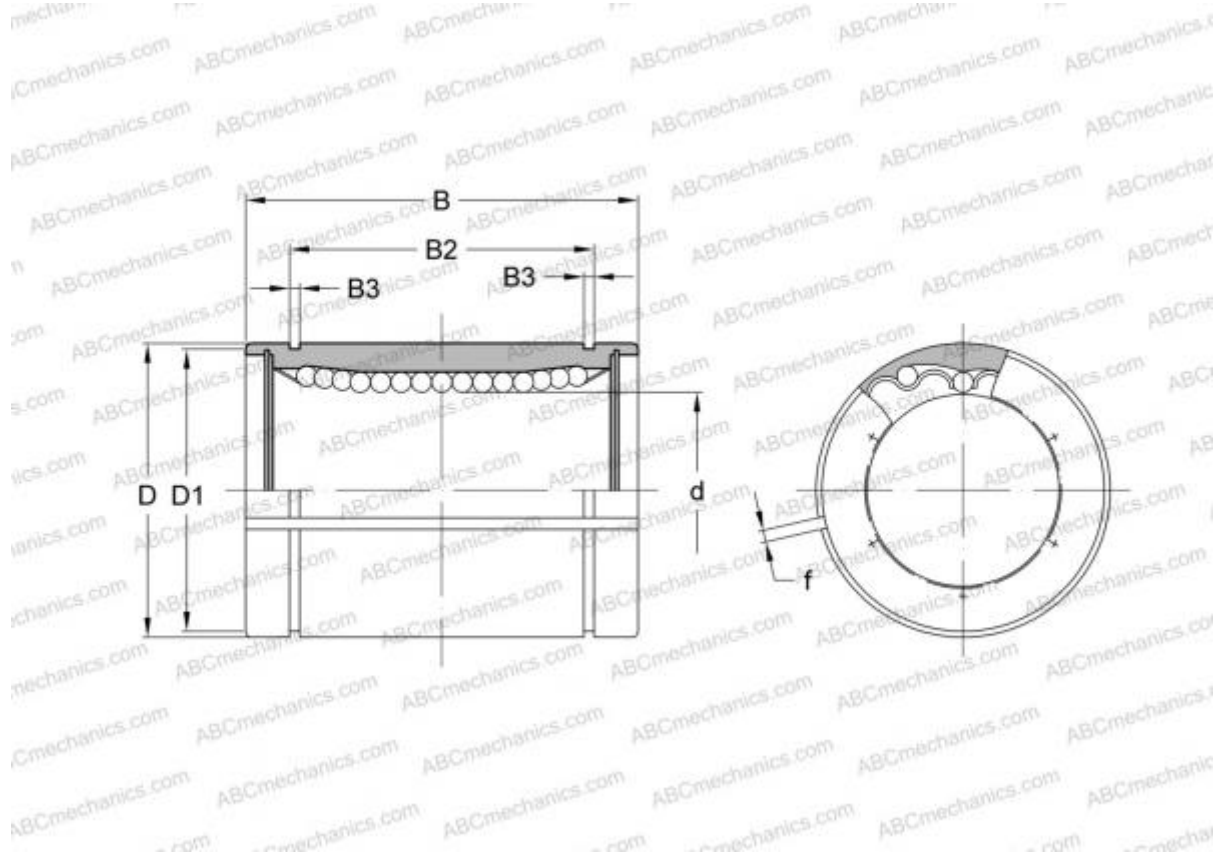

Technical specification

DIMENSIONS, MM

d	25,400
D	39,688
B	57,150
f	1,500

WEIGHT, KG 0,198

MANUFACTURER [HEIM](#)

INTERCHANGE

ABC	LMB 162536 N AJ
IKO	LMB 162536 N AJ