

LMB 203242 AJ IKO

Linear bushing

TYPE: Shaft guidance systems, Linear bushing, Standard, Adjustable type, Type LMB..(N) AJ, inch

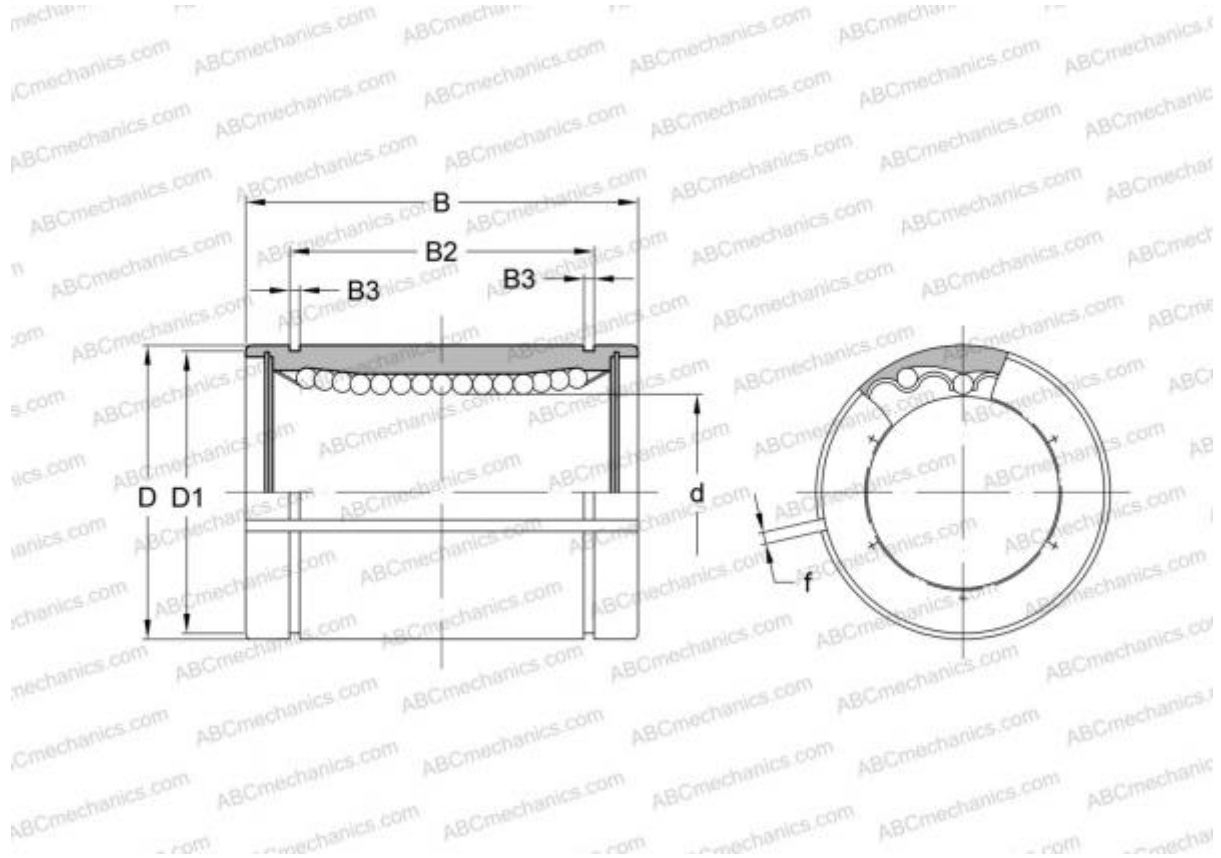

Technical specification

DIMENSIONS, MM

d	31,750
D	50,800
B	66,675
f	2,500

WEIGHT, KG 0,485

MANUFACTURER [IKO](#)

INTERCHANGE

ABC	LMB 203242 AJ
THOMSON	ADJ-203242

CALCULATION DATA

Basic dynamic load rating min	1,370 kN
Basic dynamic load rating max	1,450 kN
Basic static load rating min	2,510 kN

CALCULATION DATA

Basic static load rating max	3,210 kN
------------------------------	----------