

ADJ-203242 THOMSON

Linear bushing

TYPE: Shaft guidance systems, Linear bushing, Standard, Adjustable type, Type LMB..(N) AJ, inch

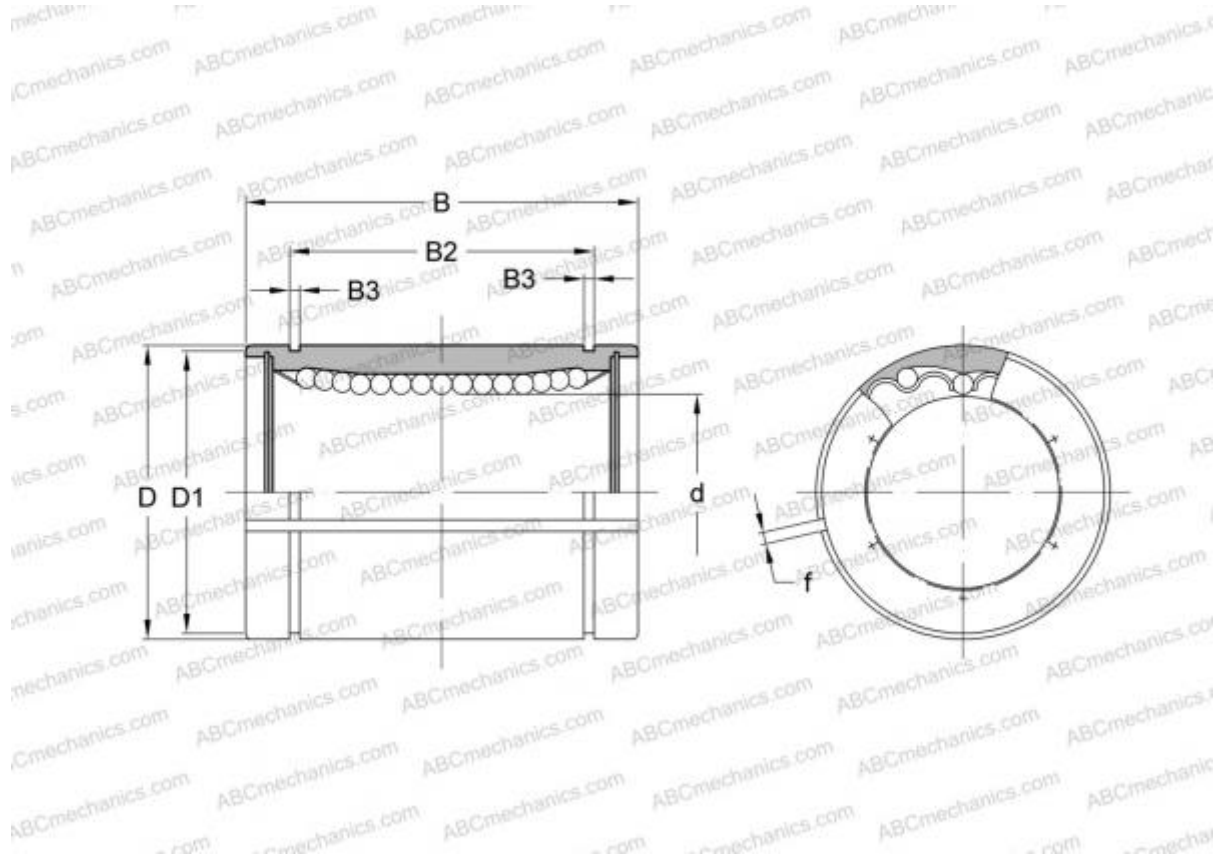

Technical specification

DIMENSIONS, MM

d	31,750
D	50,800
B	66,675
f	2,500

WEIGHT, KG 0,485

MANUFACTURER [THOMSON](#)

INTERCHANGE

ABC	LMB 203242 AJ
IKO	LMB 203242 AJ