

LMB 243848 AJ ABC

Linear bushing

TYPE: Shaft guidance systems, Linear bushing, Standard, Adjustable type, Type LMB..(N) AJ, inch

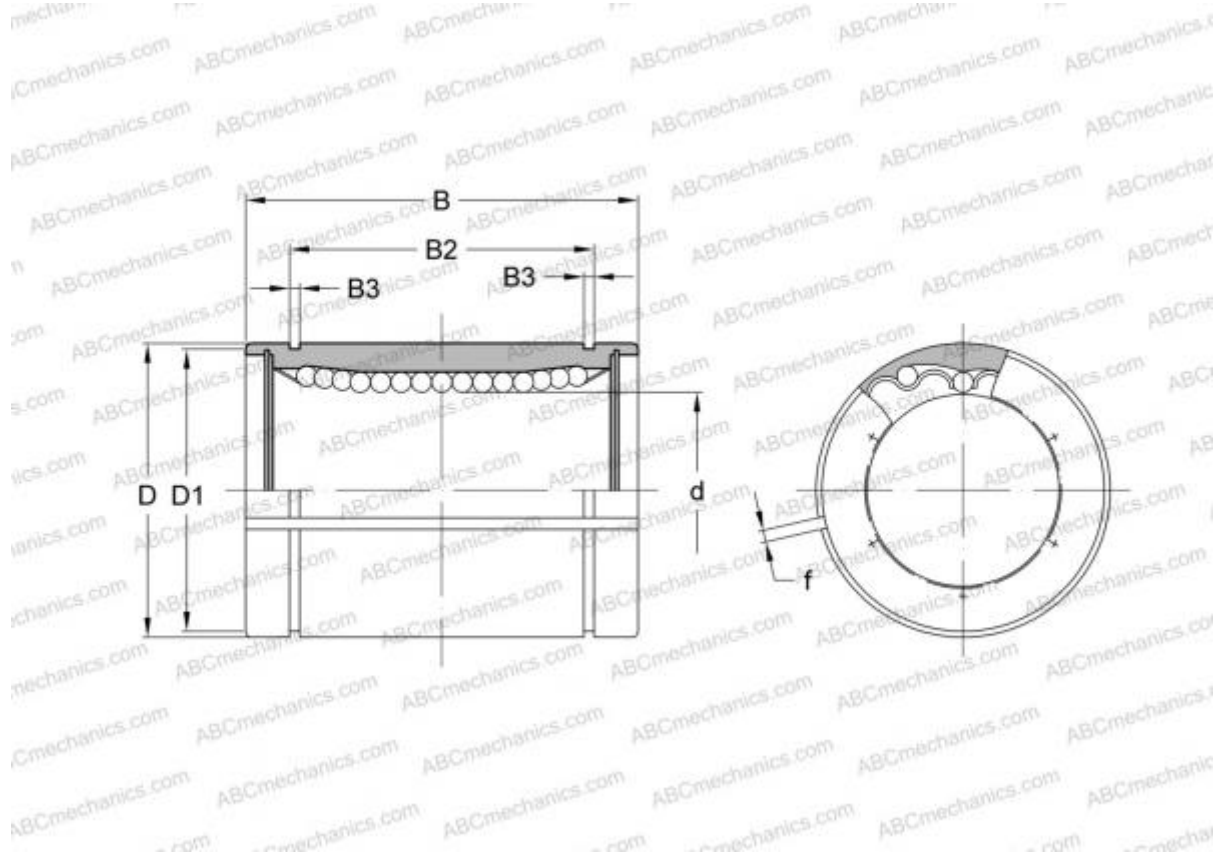

Technical specification

DIMENSIONS, MM

d	38,100
D	60,325
B	76,200
f	3,000

WEIGHT, KG 0,720

MANUFACTURER [ABC](#)

INTERCHANGE

IKO	LMB 243848 AJ
THOMSON	ADJ-243848