

LMB 243848 AJ IKO

Linear bushing

TYPE: Shaft guidance systems, Linear bushing, Standard, Adjustable type, Type LMB..(N) AJ, inch

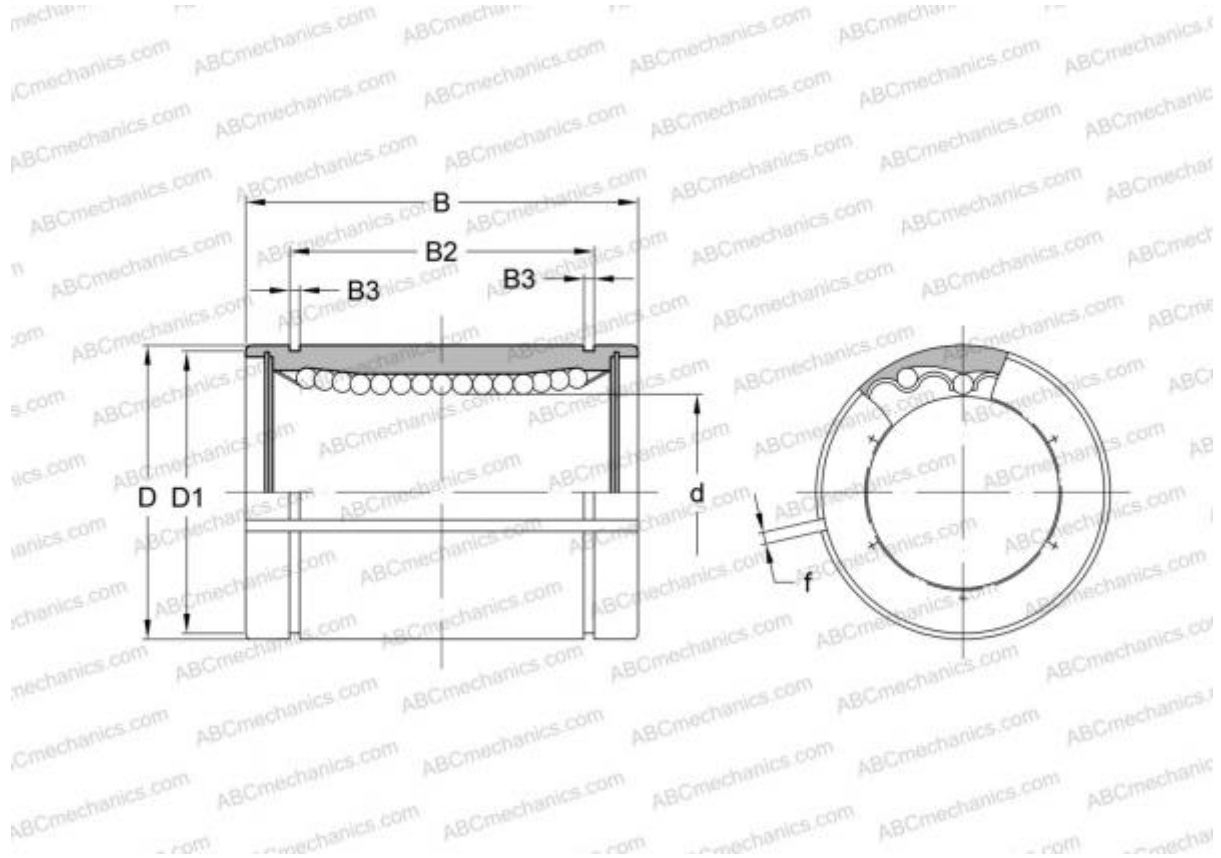

Technical specification

DIMENSIONS, MM

d	38,100
D	60,325
B	76,200
f	3,000

WEIGHT, KG 0,720

MANUFACTURER [IKO](#)

INTERCHANGE

ABC	LMB 243848 AJ
THOMSON	ADJ-243848

CALCULATION DATA

Basic dynamic load rating min	2,010 kN
Basic dynamic load rating max	2,130 kN
Basic static load rating min	3,610 kN

CALCULATION DATA

Basic static load rating max	4,620 kN
------------------------------	----------