

ADJ-243848 THOMSON

Linear bushing

TYPE: Shaft guidance systems, Linear bushing, Standard, Adjustable type, Type LMB..(N) AJ, inch

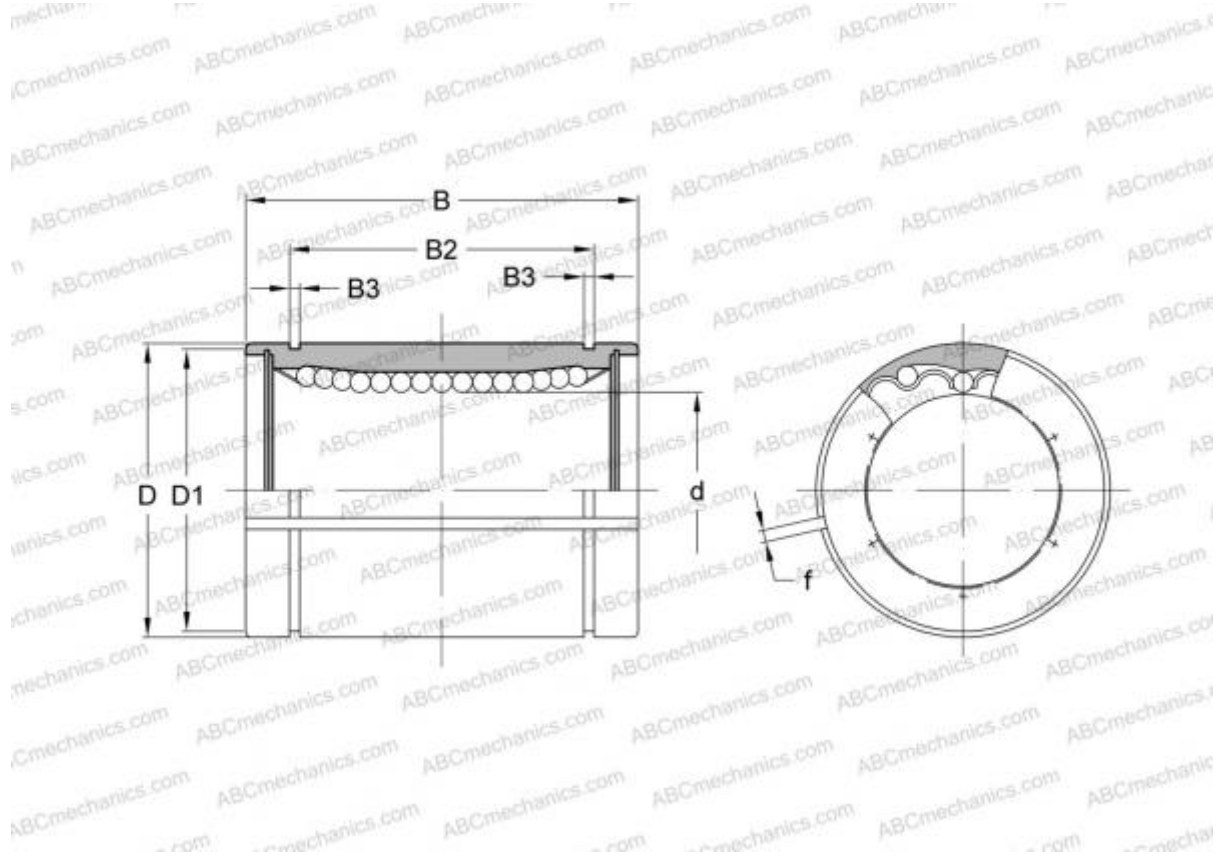

Technical specification

DIMENSIONS, MM

d	38,100
D	60,325
B	76,200
f	3,000

WEIGHT, KG 0,720

MANUFACTURER [THOMSON](#)

INTERCHANGE

ABC	LMB 243848 AJ
IKO	LMB 243848 AJ