

## LMB 243848 N AJ ABC

Linear bushing

TYPE: Shaft guidance systems, Linear bushing, Standard, Adjustable type, Type LMB..(N) AJ, inch

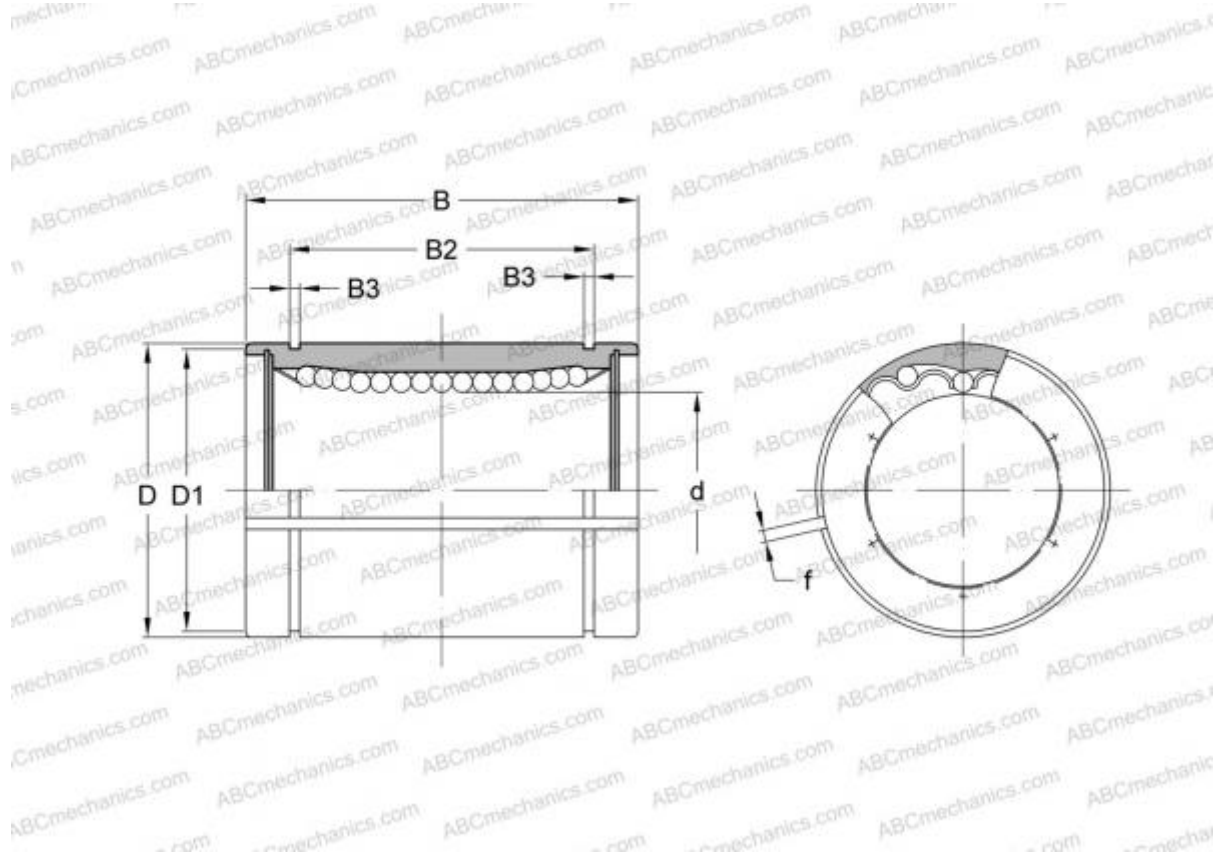

### Technical specification

#### DIMENSIONS, MM

d	38,100
D	60,325
B	76,200
f	3,000

**WEIGHT, KG** 0,660

**MANUFACTURER** [ABC](#)

#### INTERCHANGE

IKO	<a href="#">LMB 243848 N AJ</a>
HEIM	<a href="#">ADJ-1500</a>