

LMB 243848 N AJ IKO

Linear bushing

TYPE: Shaft guidance systems, Linear bushing, Standard, Adjustable type, Type LMB..(N) AJ, inch

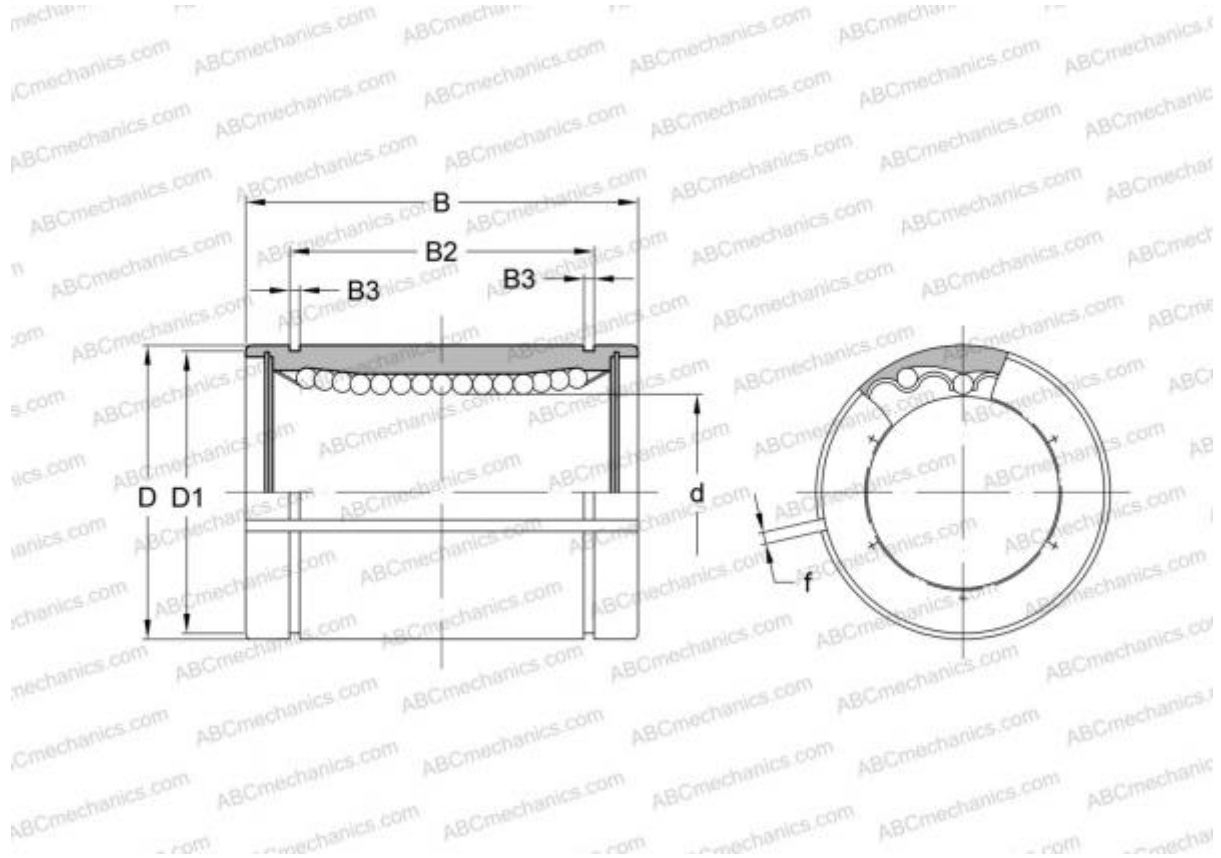

Technical specification

DIMENSIONS, MM

d	38,100
D	60,325
B	76,200
f	3,000

WEIGHT, KG 0,660

MANUFACTURER [IKO](#)

INTERCHANGE

ABC	LMB 243848 N AJ
HEIM	ADJ-1500

CALCULATION DATA

Basic dynamic load rating min	2,010 kN
Basic dynamic load rating max	2,130 kN
Basic static load rating min	3,610 kN

CALCULATION DATA

Basic static load rating max	4,620 kN
------------------------------	----------