

LMB 101824 N OP ABC

Linear bushing

TYPE: Shaft guidance systems, Linear bushing, Standard, Open type for support rail, Type LMB..(N) OP, inch

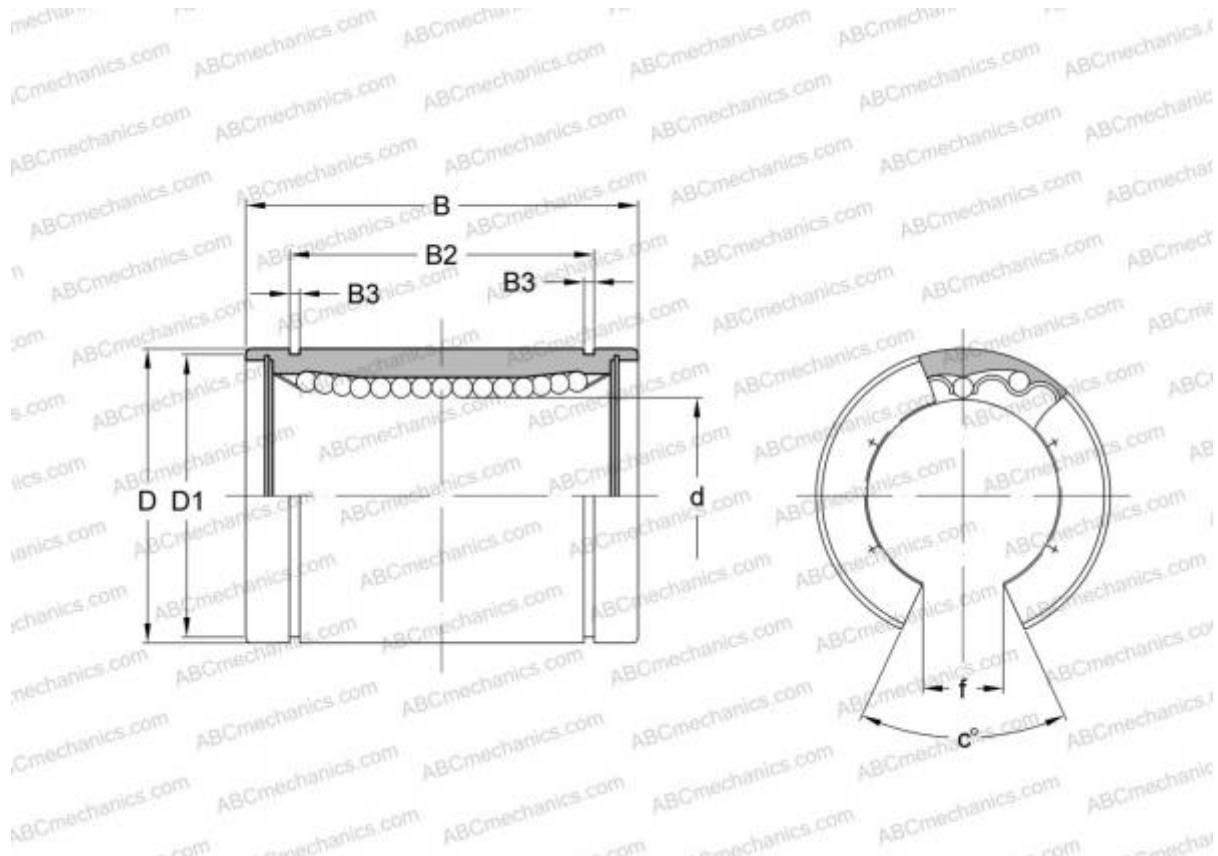

Technical specification

DIMENSIONS, MM

d	15,875
D	28,575
B	38,100
f	9,500
c	80,000

WEIGHT, KG 0,057

MANUFACTURER [ABC](#)

INTERCHANGE

IKO	LMB 101824 N OP
HEIM	OPN-625