

LMB 101824 N OP IKO

Linear bushing

TYPE: Shaft guidance systems, Linear bushing, Standard, Open type for support rail, Type LMB..(N) OP, inch

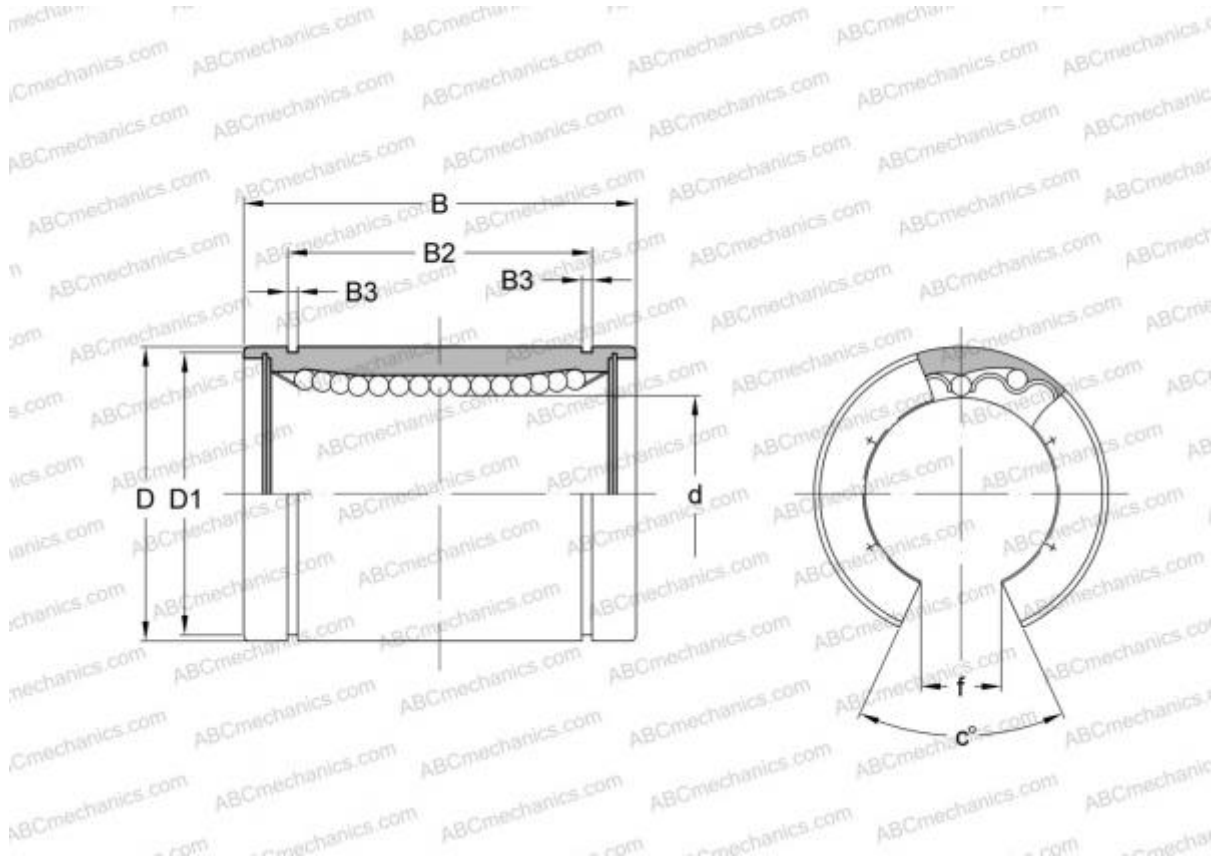

Technical specification

DIMENSIONS, MM

d	15,875
D	28,575
B	38,100
f	9,500
c	80,000

WEIGHT, KG 0,057

MANUFACTURER [IKO](#)

INTERCHANGE

ABC	LMB 101824 N OP
HEIM	OPN-625

CALCULATION DATA

Basic dynamic load rating min	0,424 kN
Basic dynamic load rating max	0,488 kN

CALCULATION DATA

Basic static load rating min	0,766 kN
Basic static load rating max	1,080 kN