

OPN-750 HEIM

Linear bushing

TYPE: Shaft guidance systems, Linear bushing, Standard, Open type for support rail, Type LMB..(N) OP, inch

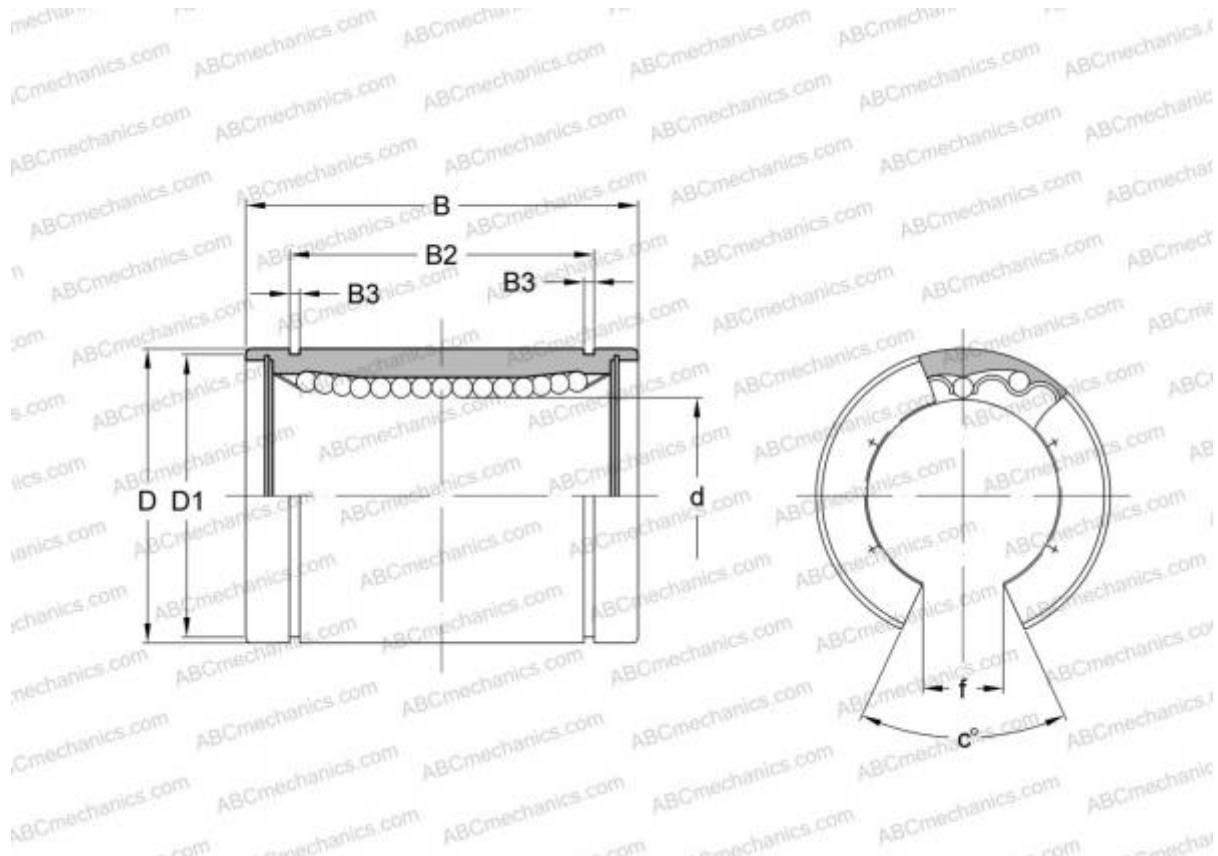

Technical specification

DIMENSIONS, MM

d	19,050
D	31,750
B	41,275
f	10,700
c	60,000

WEIGHT, KG 0,076

MANUFACTURER [HEIM](#)

INTERCHANGE

ABC	LMB 122026 N OP
IKO	LMB 122026 N OP