

LMS 4 FUU IKO

Linear bushing

TYPE: Shaft guidance systems, Linear bushing, Standard, Close type, Type LMS, LMSL, miniature (IKO)

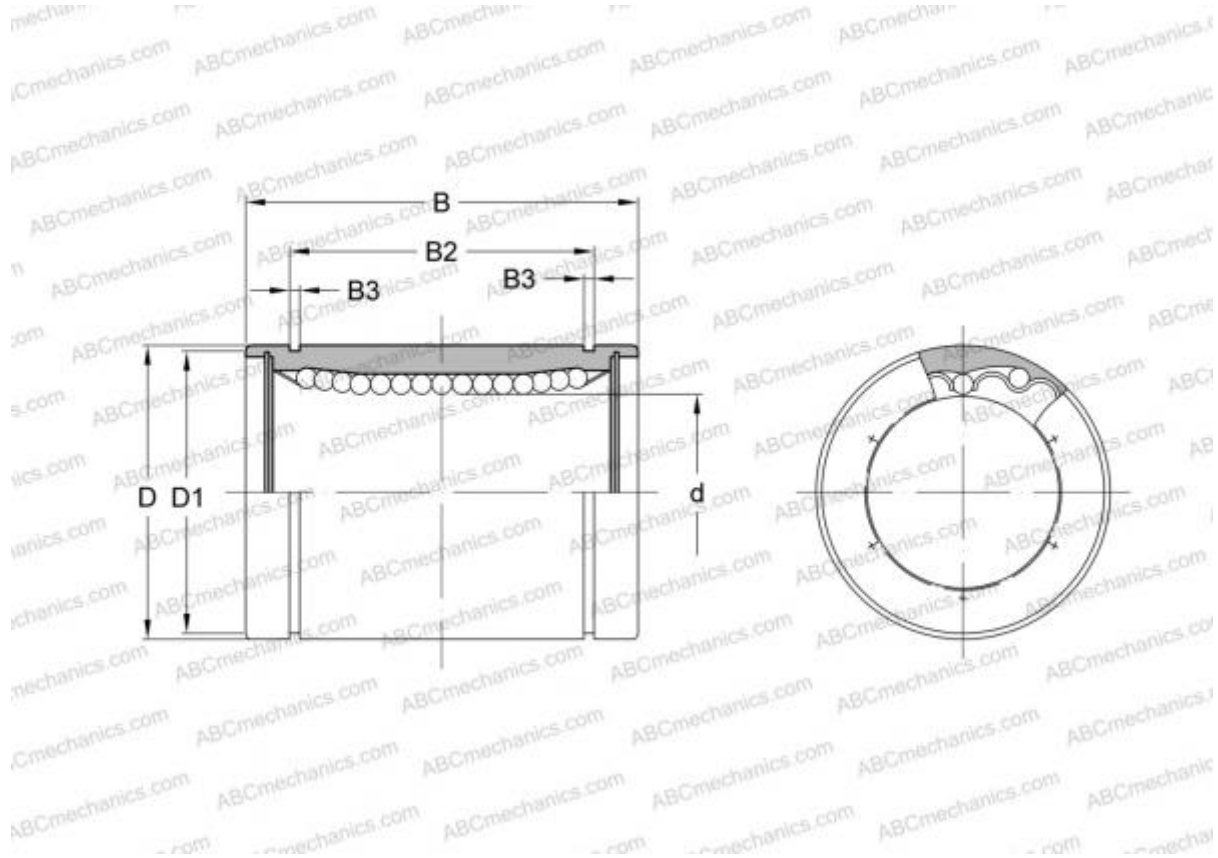

Technical specification

DIMENSIONS, MM

d	4,000
D	8,000
B	12,000

WEIGHT, KG 0,003

MANUFACTURER [IKO](#)

CALCULATION DATA

Basic dynamic load rating min	0,023 kN
Basic dynamic load rating max	0,027 kN
Basic static load rating min	0,049 kN
Basic static load rating max	0,069 kN