

## KH06-PP INA

Linear bushing

TYPE: Shaft guidance systems, Linear bushing, Compact type, Type KH..PP, LK..UU, sealed on both sides

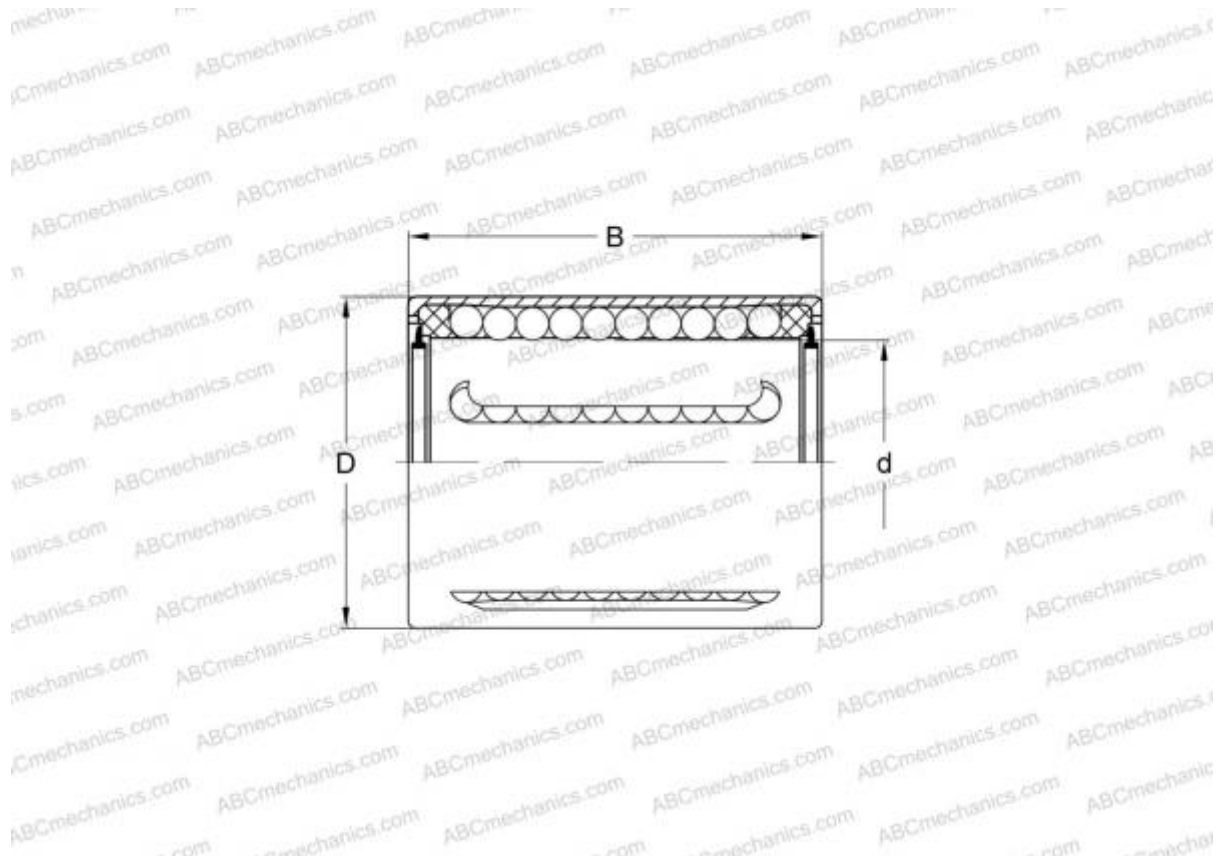

### Technical specification

#### DIMENSIONS, MM

d	6,000
D	12,000
B	22,000

**WEIGHT, KG** 0,007

**MANUFACTURER** [INA](#)

#### INTERCHANGE

ABC	<a href="#">KH06-PP</a>
-----	-------------------------