

## KH08-PP ABC

Linear bushing

TYPE: Shaft guidance systems, Linear bushing, Compact type, Type KH..PP, LK..UU, sealed on both sides

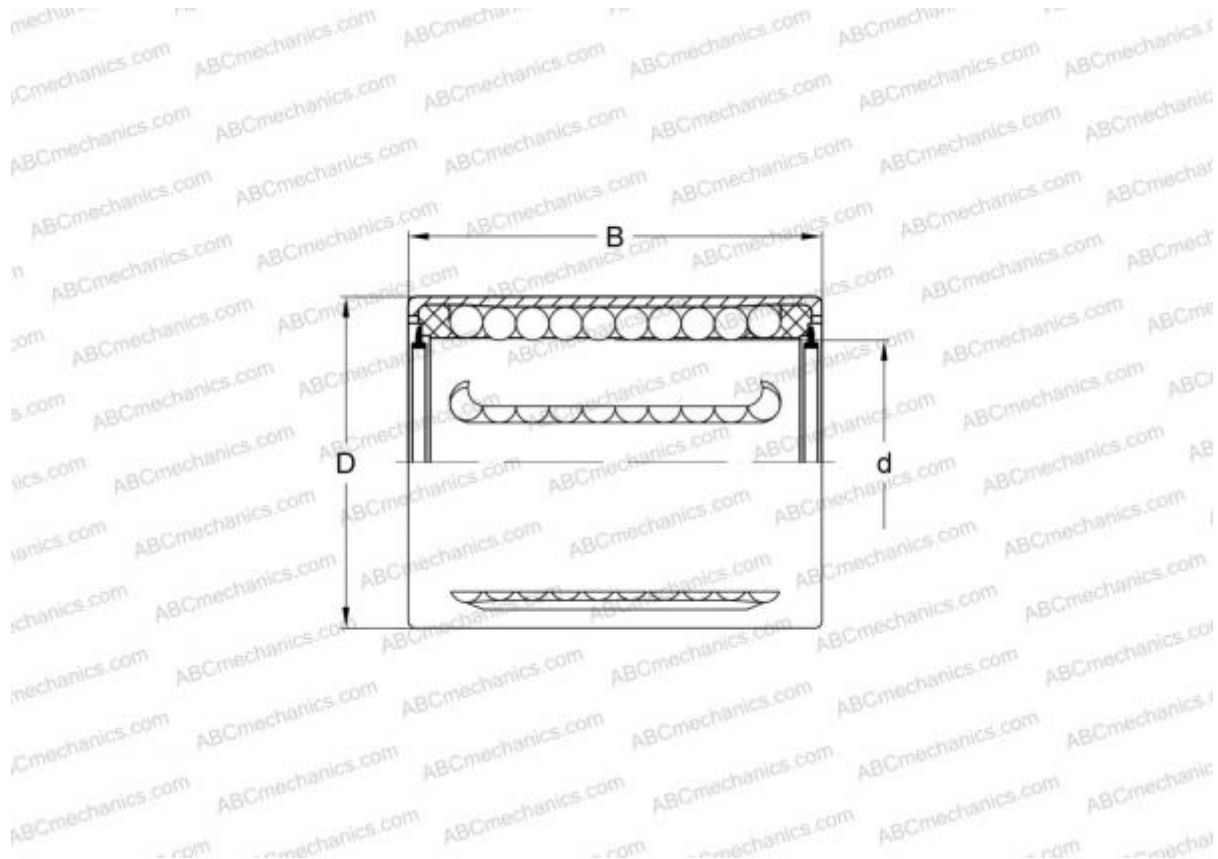

### Technical specification

#### DIMENSIONS, MM

|   |        |
|---|--------|
| d | 8,000  |
| D | 15,000 |
| B | 24,000 |

**WEIGHT, KG** 0,012

**MANUFACTURER** [ABC](#)

#### INTERCHANGE

|     |                         |
|-----|-------------------------|
| INA | <a href="#">KH08-PP</a> |
|-----|-------------------------|