

## KH08-PP INA

Linear bushing

TYPE: Shaft guidance systems, Linear bushing, Compact type, Type KH..PP, LK..UU, sealed on both sides

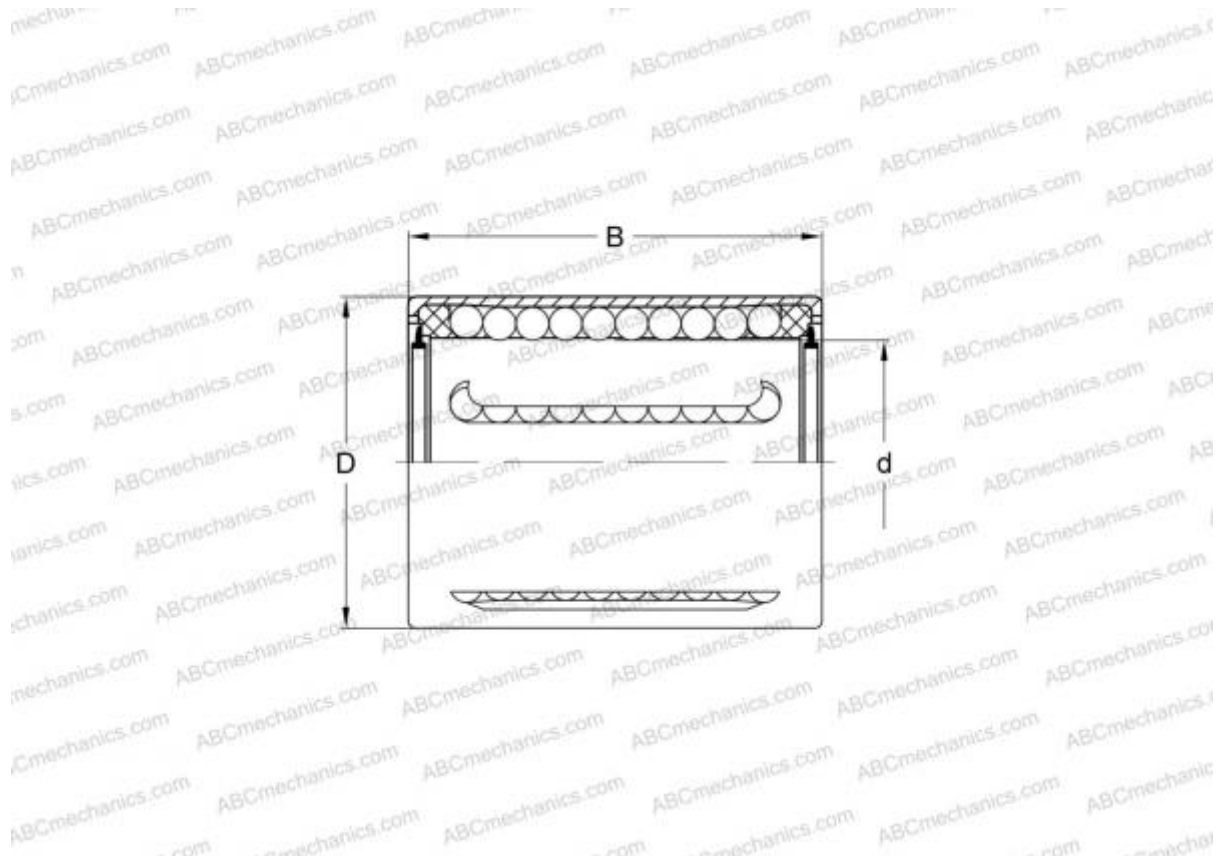

### Technical specification

#### DIMENSIONS, MM

d	8,000
D	15,000
B	24,000

**WEIGHT, KG** 0,012

**MANUFACTURER** [INA](#)

#### INTERCHANGE

ABC	<a href="#">KH08-PP</a>
-----	-------------------------