

KH12-PP ABC

Linear bushing

TYPE: Shaft guidance systems, Linear bushing, Compact type, Type KH..PP, LK..UU, sealed on both sides

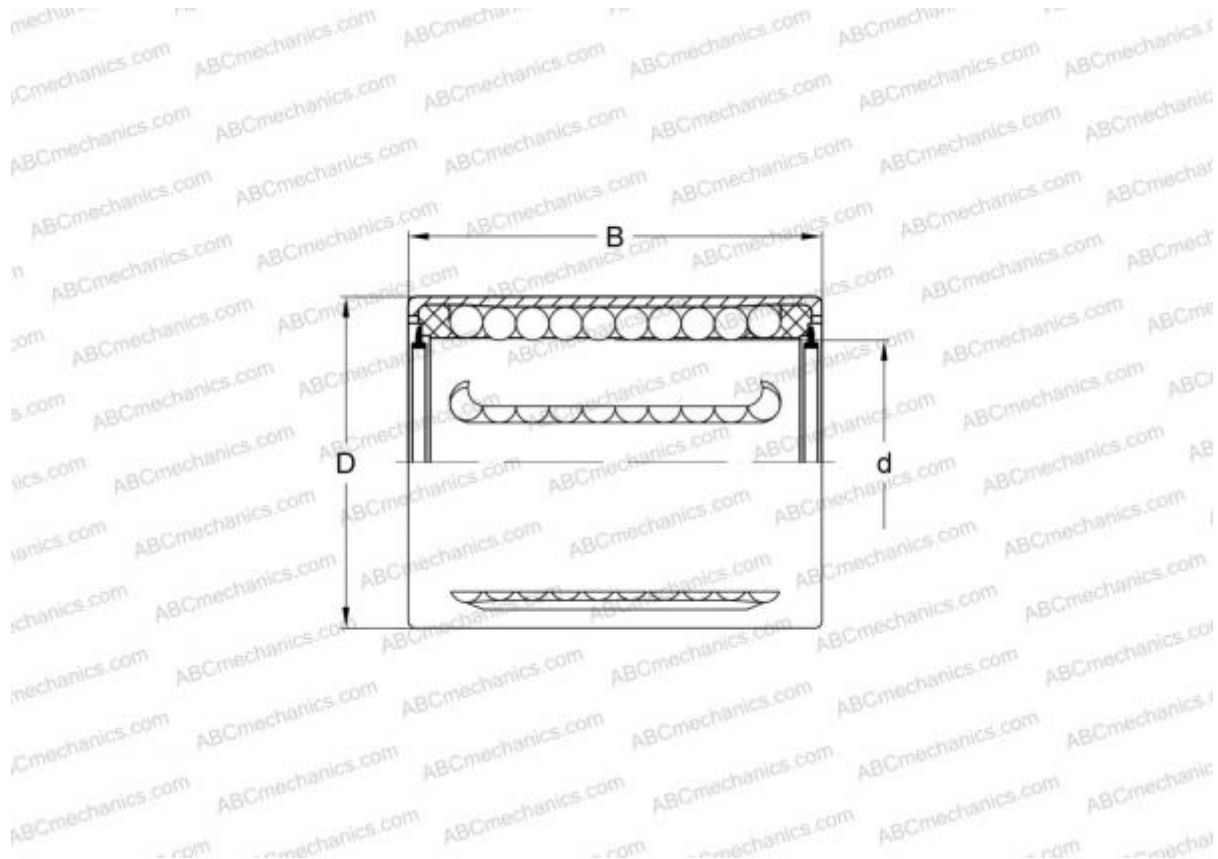

Technical specification

DIMENSIONS, MM

d	12,000
D	19,000
B	28,000

WEIGHT, KG 0,019

MANUFACTURER [ABC](#)

INTERCHANGE

INA	KH12-PP
-----	-------------------------