

KH14-PP INA

Linear bushing

TYPE: Shaft guidance systems, Linear bushing, Compact type, Type KH..PP, LK..UU, sealed on both sides

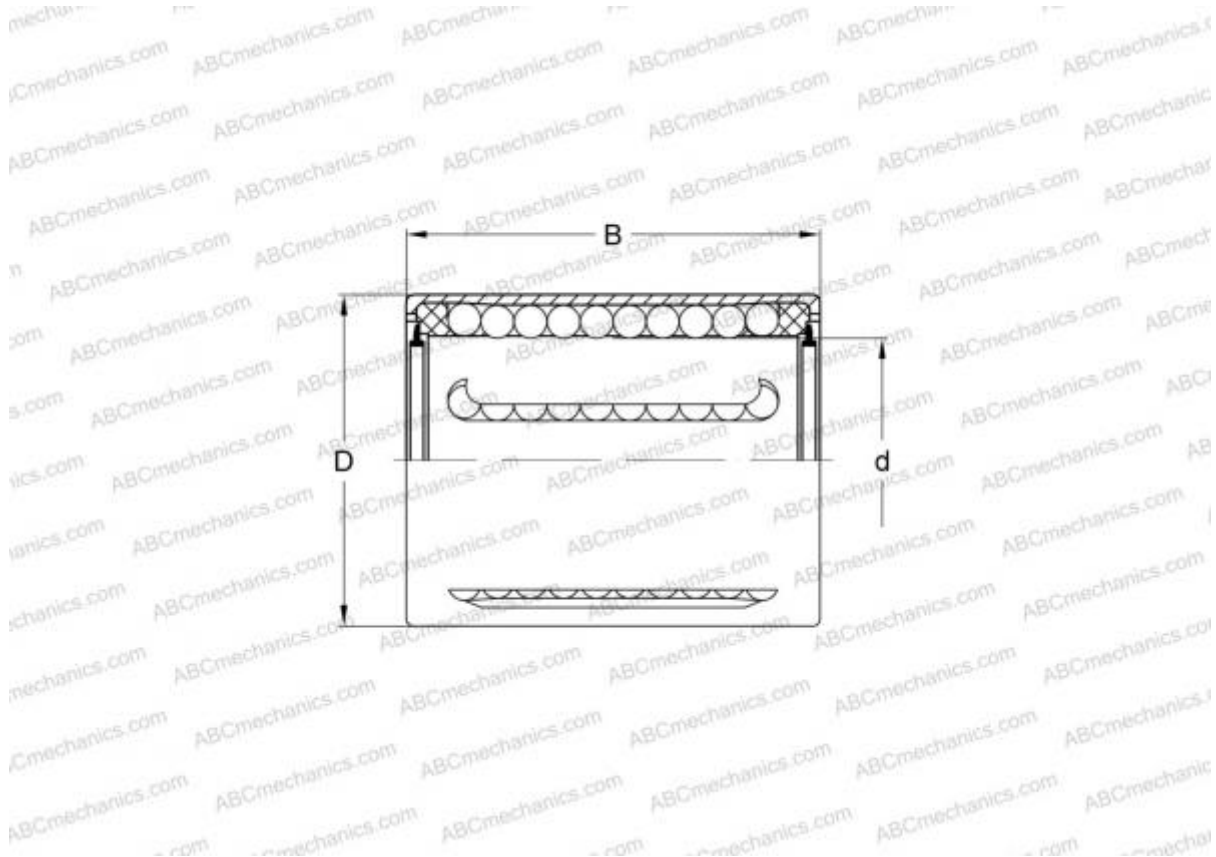

Technical specification

DIMENSIONS, MM

d	14,000
D	21,000
B	28,000

WEIGHT, KG 0,021

MANUFACTURER [INA](#)

INTERCHANGE

ABC	KH14-PP
-----	-------------------------