

## LAH35AN NSK

Linear guides

TYPE: Monorail guidance systems, Recirculating balls, High vertical load carrying capacity type, Self-aligning type, Square type, High, Ball slide length - standard, Mounting tap, Interchangeable part

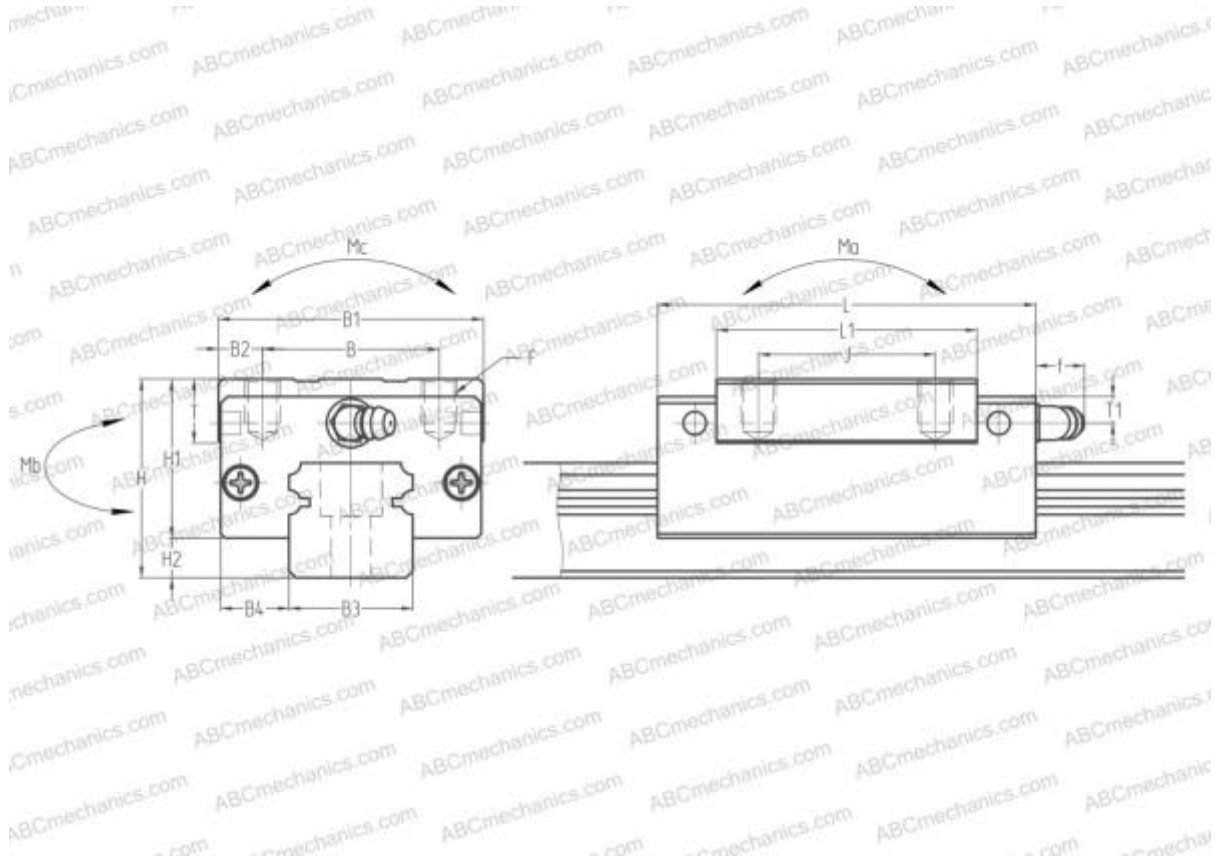

### Technical specification

#### DIMENSIONS, MM

B1	70,000
H	55,000
L	109,000
B	50,000
J	50,000
L1	80,000
B2	10,000
B3	34,000
B4	18,000
H1	45,500
H2	9,500
T	15,000
T1	15,000
f	11,000
F	M8x1.25x12

#### SLIDE WEIGHT

1,500

#### MANUFACTURER

[NSK](#)

#### CALCULATION DATA

Basic dynamic load rating, C	39,000 kN
Basic static load rating, Co	68,500 kN
Static permissible moment, Ma	0,735 kN-m
Static permissible moment, Mb	0,715 kN-m
Static permissible moment, Mc	0,940 kN-m