

## LWHDG30 IKO

Linear guides

TYPE: Monorail guidance systems, Recirculating balls, High vertical load carrying capacity type, Self-aligning type, Square type, High, Ball slide length - long, Mounting tap

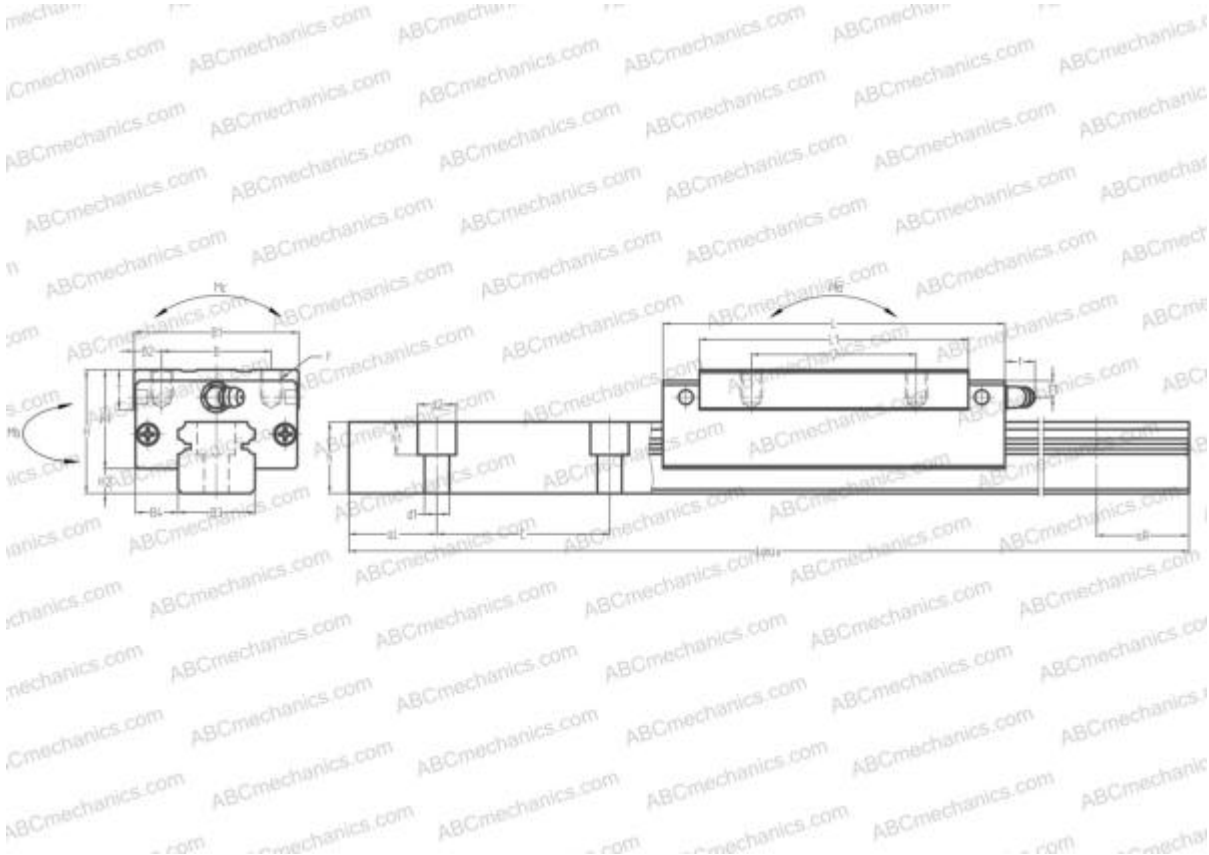

### Technical specification

#### DIMENSIONS, MM

B1	60,000
H	45,000
L	124,600
B	40,000
J	60,000
L1	98,000
B2	10,000
B3	28,000
B4	16,000
H1	36,000
H2	9,000
T	14,000
T1	10,000
f	11,000
C	80,000

#### DIMENSIONS, MM

d1	9,000
d2	14,000
h	26,000
h1	12,000
L max	4000,000
aL	20,000
aR	20,000
F	M8x1.25x10

#### WEIGHT

Slide weight	1,300
Rail weight	5,200

#### MANUFACTURER

[IKO](#)

#### INTERCHANGE

ABC	<a href="#">LH30BN</a>
NSK	<a href="#">LH30BN</a>

**INTERCHANGE**

THK	<a href="#">HSR30LR</a>
HIWIN	<a href="#">HGH30HA</a>
STAR	<a href="#">1624-7</a>
Rockford Linear Motion	<a href="#">RPG30HRL</a>
INA	<a href="#">KUV30-B-HL</a>
THOMSON	<a href="#">AG 30HE</a>
SCHNEEBERGER	<a href="#">BMD 30</a>