

HSR35LR THK

Linear guides

TYPE: Monorail guidance systems, Recirculating balls, High vertical load carrying capacity type, Self-aligning type, Square type, High, Ball slide length - long, Mounting tap

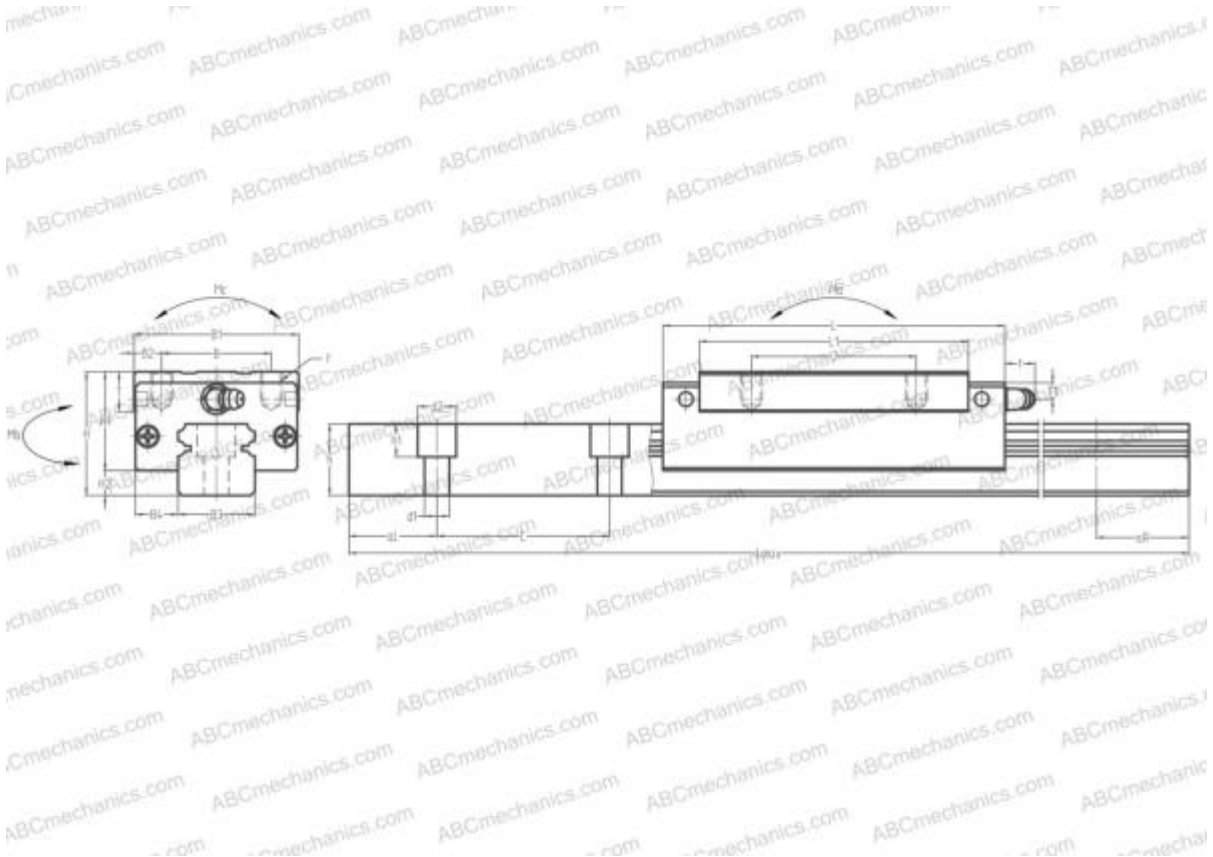

Technical specification

DIMENSIONS, MM

B1	70,000
H	55,000
L	143,000
B	50,000
J	72,000
L1	114,000
B2	10,000
B3	34,000
B4	18,000
H1	45,500
H2	9,500
T	15,000
T1	15,000
f	11,000
C	80,000

DIMENSIONS, MM

d1	9,000
d2	14,000
h	29,000
h1	12,000
L max	4000,000
aL	20,000
aR	20,000
F	M8x1.25x12

WEIGHT

Slide weight	2,100
Rail weight	7,200

MANUFACTURER

[THK](#)

INTERCHANGE

ABC	LH35BN
NSK	LH35BN

INTERCHANGE

IKO	LWHDG35
HIWIN	HGH35HA
STAR	1624-3
Rockford Linear Motion	RPG35HRL
INA	KUV35-B-HL
THOMSON	AG 35HE
SCHNEEBERGER	BMD 35