

## AG 35HE THOMSON

Linear guides

TYPE: Monorail guidance systems, Recirculating balls, High vertical load carrying capacity type, Self-aligning type, Square type, High, Ball slide length - long, Mounting tap

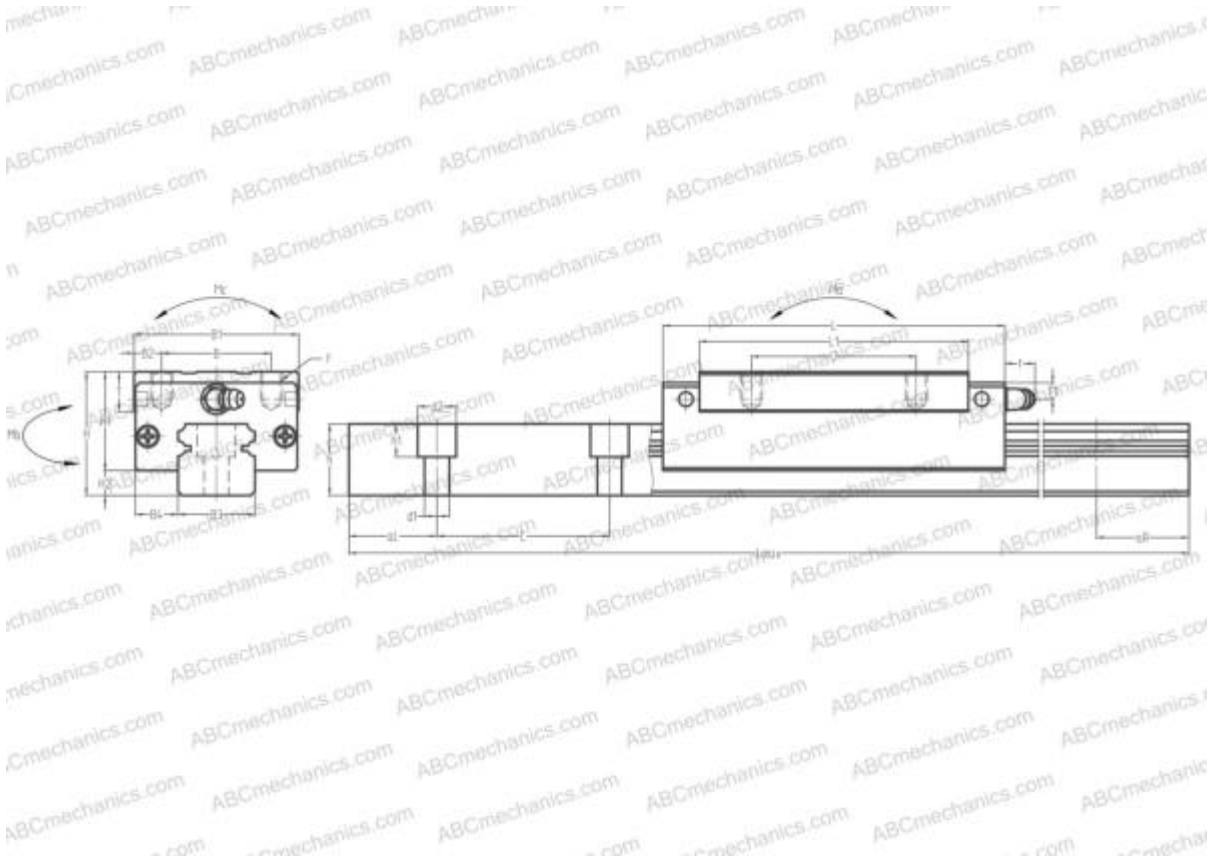

### Technical specification

#### DIMENSIONS, MM

B1	70,000
H	55,000
L	143,000
B	50,000
J	72,000
L1	114,000
B2	10,000
B3	34,000
B4	18,000
H1	45,500
H2	9,500
T	15,000
T1	15,000
f	11,000
C	80,000

#### DIMENSIONS, MM

d1	9,000
d2	14,000
h	29,000
h1	12,000
L max	4000,000
aL	20,000
aR	20,000
F	M8x1.25x12

#### WEIGHT

Slide weight	2,100
Rail weight	7,200

#### MANUFACTURER

[THOMSON](#)

#### INTERCHANGE

ABC	<a href="#">LH35BN</a>
NSK	<a href="#">LH35BN</a>

**INTERCHANGE**

THK	<a href="#">HSR35LR</a>
IKO	<a href="#">LWHDG35</a>
HIWIN	<a href="#">HGH35HA</a>
STAR	<a href="#">1624-3</a>
Rockford Linear Motion	<a href="#">RPG35HRL</a>
INA	<a href="#">KUV35-B-HL</a>
SCHNEEBERGER	<a href="#">BMD 35</a>